



nanni

ENERGY IN BLUE

www.nannienergy.com



PRODUCT GUIDE

NANNI POWER SYSTEMS

With a range of high quality propulsion engines and generator sets, Nanni is able to provide complete power systems for marine applications.

This product selection guide includes a comprehensive range of propulsion engines from 10 to 1200 hp, and marine generator sets from 6 to 500 kW.

This guide is intended to provide an overview of our product range while helping the prospective buyer to select the appropriate Nanni product.

CONTENT

Nanni at a glance	02
Sail with confidence	03
Using this guide	04
Dimensions & Weight	05
Ratings outline	06
Regulations.....	10
Propulsion engines	12
Sail Drive propulsion system.....	14
Stern Drive propulsion system	28
Marex control systems	44
Interactive control systems.....	48
Generator sets.....	50
Nanni Hybrid system.....	62

Despite all the care taken in publishing this brochure, Nanni Industries cannot be held responsible for any error introduced in the content.

In the interest of progress, please kindly note that model designations, ratings and specifications are subject to change without prior notice.

NANNI AT A GLANCE

Nanni is an independent international company founded in 1952 and is now France's leading marine engine manufacturer.

The company designs, develops, manufactures and markets engines and generator sets designed specifically for the challenge of marine applications. Nanni also provides all related technologies, including fuel systems, controls, air handling, filtration, emission solutions and electrical power generation systems. With its comprehensive product range, Nanni offers content in all power and application categories, and is able to provide a full range of solutions, from bobtail engines to complete power systems.

Headquartered in France, the production unit and the design office are certified as compliant with ISO 9001 standards.

Learn more about Nanni on nannienergy.com

Worldwide customer support network

Nanni products are supported at every major port thanks to a worldwide network of independent distributor facilities and dealer locations, delivering the expertise and parts needed to keep customer's products running smoothly.

In choosing a Nanni product, you gain an extensive worldwide sales and service network to help you achieve maximum engine life and sustained reliability.



SAIL WITH CONFIDENCE

Nanni has been a global marine engine manufacturer for over 60 years, offering customers industry-leading durability and reliability. As a result, many of Nanni's legacy engines are still powering boats around the globe.

Known for their reliability, its products are the driving force behind many power systems worldwide. The long and successful partnership with customers including major shipyards and governmental agencies provides further evidence that you can rely on a solid partner.

Robust, efficient & built to last. These are the qualities that have made Nanni's reputation. We design simple, yet effective and reliable products able to withstand the toughest conditions, year after year.

And when it comes to fuel consumption and maintenance costs, Nanni is also an attractive choice. Not only because of products quality, but also thanks to an established know-how in marine power systems and full engineering team support throughout project realization. From the first stage, through the sales process and commissioning, to parts supply, maintenance, repair and upgrade, Nanni offers a full range of services.

Nanni, your single source for complete power systems.



USING THIS GUIDE

PROPULSION ENGINES

For propulsion engines, the application ratings reflect various boat operation needs. Knowledge of the engine's operating requirements is therefore essential to establish a proper match of engine rating to boat operating requirements.

Consider the expected annual operating hours based on the annual 12-month period. Also consider the duty cycle, which refer to the amount of time the engine is required to be operated at rated rpm during a period of time. Then review the presented application ratings and decide which rating best defines the application. Also foresee the regulations that the engine will have to meet. Once you have decided which rating and emission level fit your needs, refer to the specification tables beginning on page 6 and on page 10 for ratings and regulations availability by engine model.

Finally, use the engine model pages for additional information to help you decide which Nanni engine best fits your operating needs. The type of transmissions that are available for each engine are indicated.

More information is provided on specific product brochures available for each engine on www.nannidiesel.com.

GENERATOR SETS

For generator sets, first refer to the overview on page 40 and determine the series that best suits your application. Proceed to the sizing step by making an inventory of on-board electrical appliances. Add their rated power together and foresee which appliances will operate simultaneously. Also establish important project parameters such as load capacity, voltage, single or three-phase, maximum allowable voltage and frequency drop, etc.

As always, refer to www.nannidiesel.com or consult your Nanni representative for assistance and for the most up-to-date information.

DIMENSIONS & WEIGHT

Dimensions and weight may vary according to the configuration selected. More detailed information is included within the specific installation schematic for each product.

Stated weight values are based on dry engines including standard equipment without coolant, oil and transmission.

Sizing is defined according to the following schematic diagram:

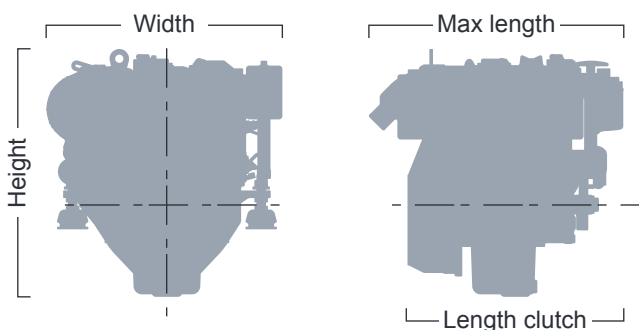

For propulsion engines, performance data are provided in accordance with ISO 8665-1, as follows:

- kW: Rated engine power in kilowatts
- hp: Rated engine power in metric horsepower
- rpm: Rated engine speed in revolutions per minute
- l/h: Max fuel consumption at rated engine speed in litres per hour.
Fuel consumption has a tolerance of +/- 5%

For generator sets, power rating are given according ISO 8528-1. Dimensions are given as the maximum overall length, width and height. Weights are based on dry engines, without coolant and oil.

RATINGS OUTLINE

For an exact determination of the appropriate rating, contact your local Nanni representative.

M1.L rating

Operating hours	Unlimited
Load factor ¹	Up to 100%
Duty cycle ²	Uninterrupted full power
Application example	ICFN (continuous)

M1.S rating

Operating hours	Unlimited
Load factor ¹	Up to 80%
Duty cycle ²	Full power for no more than 1 hour out of each 3 hours of operation
Application example	IFN (intermittent)

M1 rating

Operating hours	24 hours per day
Load factor ¹	Over 65%
Duty cycle ²	Uninterrupted full power
Application example	Line hauls tugs and towboats, trawlers/draggers, displacement hull fishing boats

M2 rating

Operating hours	Up to 5000 hours per year
Load factor ¹	Up to 65%
Duty cycle ²	Full power for no more than 16 hours out of each 24 hours of operation
Application example	Short-range tugs and towboats long-range ferryboats, large passenger vessels and offshore displacement hull fishing boats

M3 rating

Operating hours	Up to 4000 hours per year
Load factor ¹	Up to 50%
Duty cycle ²	Full power for no more than 4 hours out of each 12 hours of operation
Application example	Coastal fishing boats offshore crew boats, research boats. Short range ferryboats and dinner cruise boats

M4 rating

Operating hours	Up to 3000 hours per year
Load factor ¹	Up to 40%
Duty cycle ²	Full power for no more than 1 hour out of each 12 hours of operation
Application example	Inshore crew boats, charter fishing boats, pilot boats, dive boats, and planning hull commercial fishing boats

M5.L rating

Operating hours	Up to 2000 hours per year
Load factor ¹	Up to 77%
Duty cycle ²	Full power for no more than 1 hour out of each 6 hours of operation
Application example	Patrol craft long

M5.S rating

Operating hours	Up to 1200 hours per year
Load factor ¹	Up to 77%
Duty cycle ²	Full power for no more than 1 hour out of each 12 hours of operation
Application example	Patrol craft short

M5 rating

Operating hours	Up to 1000 hours per year
Load factor ¹	Up to 35%
Duty cycle ²	Full power for no more than 30 minutes out of each 8 hours of operation
Application example	Recreational boats, tactical military vessels and rescue boats

M6.S rating

Operating hours	Up to 500 hours per year
Load factor ¹	Up to 50%
Duty cycle ²	Full power for no more than 1 hour out of each 20 hours of operation
Application example	Pleasure craft

M6 rating

Operating hours	Up to 500 hours per year
Load factor ¹	Up to 35%
Duty cycle ²	Full power for no more than 30 minutes out of each 8 hours of operation
Application example	Recreational boats

¹ Load factor : fuel burned over a period of time divided by the full-power fuel consumption over the same period.

² Duty cycle : the remaining operation time must be at or below cruising speeds. Cruising speed is at least 200 rpm below the rated engine speed. No wide-open throttle below rated engine speed.



REGULATIONS

EXHAUST EMISSIONS

IMO-MARPOL Annex VI

Main international convention concerning the prevention of marine environment pollution by shipping. Only applies to diesel engines above 130 kW.

EU-Directive 2013/53/EU (RCD 2)

European Union design regulations for recreational craft up to a hull length of 24 m.

EU-Regulation 2016/1628 NRMM Stage IV

The Nonroad Mobile Machinery Directive regulates exhaust emissions from marine propulsion and auxiliary engines used aboard inland waterway vessels operating in the European Community.

EPA marine Tier 3

Managed by the Environmental Protection Agency of the U.S.A, the EPA certification regulates exhaust emissions from diesel engines installed on U.S. registered marine vessels.

BSO 2

The BSO standard applies to recreational marine engines operating on lake Constance.

On-demand certifications

Some regions in the world have local regulations for a specific area or water (ie., NKK, RMRS, CCR, etc.). Contact your Nanni representative for details and availability of further engine certification in these cases.

Certain products may not be available for sale in all areas due to emissions compliance.

CLASSIFICATION SOCIETY

Nanni works with various marine classification societies to allow the use of our engines in vessels designed and built to a society's particular requirements. For more information, please contact your local Nanni representative.

SOLAS

The SOLAS (Safety Of Life At Sea) is an international treaty that prescribes several rules regarding the safety of ships. Our SOLAS approved engines are designed and manufactured to meet these regulations for use in life, rescue and crew tender boats. Special features do include:

- Immediate starting in very low temperatures (down to -15°C , and -25°C with additional heater).
- Operation at an angle up to 30° in intermittent operation and 20° in continuous operation.
- All SOLAS approved engines have been engineered to be installed in free fall life boats and are able to withstand a drop from a height of more than 30 meters.

PROPULSION ENGINES

The references indicated hereafter identify the regulations each propulsion engine will be certified to:

1. IMO MARPOL Annex VI compliant
2. RCD2 2013/53/EU
3. EU Regulation 2016/1628 NRMM Stage IV
4. EPA Marine Tier 3
5. BSO 2

Engine	Rated Power [hp]	Rating	Emissions level	Page
N2.10	10	M5	2, 4, 5	18
N2.14	14	M5	2, 4, 5	19
N3.21	19.6	M5	2, 4, 5	20
N3.30	29	M5	2, 4, 5	21
N4.38	37.5	M4	2, 4, 5	22
N4.40	40	M4	2, 4	23
N4.50	47.5	M4	2, 4, 5	24
N4.65	59	M4	2, 4	25
N4.80	79	M5	2, 4, 5	26
N4.115	115	M4	2, 4, 5	27
N4.140	135	M5	2, 4, 5	27
T4.205	200	M6	1, 2, 4, 5	30
T4.230	230	M6	1, 2, 4, 5	30
T4.270	265	M6	1, 2, 4, 5	30
6.420 TDI	320	M6	5	32
T8V.320	320	M6	1, 2, 4	33
T8V.350	350	M6	1, 2, 4	33
T8V.370	370	M6	1, 2, 4	33
N5.150	152	M4	n/a	34
N5.160 CR2	162	M1	1, 4	34
N5.180 CR2	182	M2	1, 4	34
N5.200 CR2	202	M3	1, 4	34
N5.230 CR2	228	M4	1, 4	34
N6.160	156	M1	n/a	36
N6.180	177	M2	n/a	36
N6.200	202	M3	n/a	36
N6.230	228	M4	n/a	36
N6.250 CR2	250	M1	1, 4	36

Engine	Rated Power [hp]	Rating	Emissions level	Page
N6.285 CR2	284	M2	1, 4	36
N6.325 CR2	325	M3	1, 4	36
N6.360 CR2	360	M4	1, 4	36
N6.405 CR2	405	M5	1, 4	36
N9.330 CR2	329	M1	1, 4	37
N9.380 CR2	380	M2	1, 4	37
N9.430 CR2	431	M3	1, 2, 4	37
N9.510 CR2	507	M4	1, 2, 4	37
N9.600 CR2	557	M5	1, 2, 4	37
N13.430 CR2	431	M1	1, 2, 4	39
N13.510 CR2	507	M2	1, 2, 4	39
N13.580 CR2	583	M3	1, 2, 4	39
N13.660 CR2	659	M4	1, 2, 4	39
N13.800 CR2	760	M5	1, 2, 4	39
N13.700 CR3	700	M1.S	1, 2, 4	41
N13.750 CR3	751	M6.S, M5.L	1, 2, 4	41
N13.800 CR3	800	M6.S, M5.L	1, 2, 4	41
N13.900 CR3	900	M6.S	1, 2, 4	41
N13.930 CR3	925	M6.S	1, 2	42
N16.900 CR3	900	M1.S	1, 2	42
N16.1000 CR3	1000	M6.S	1, 2	42
N16.1100 CR3	1100	M6.S	1, 2	42
N16.1150 CR3	1150	M6.S	1, 2	42
N16.1200 CR3	1200	M6.S	1, 2	42

NANNI RANGE (hp)

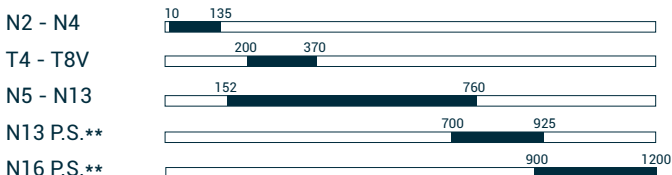

**P.S. : PLATINUM SERIES

SAIL DRIVE PROPULSION SYSTEM

Available for engines up to 135 hp, the Sail Drive transmission system provides to both the OEM manufacturer and boat owners a unique, still proven design.

It offers quiet and virtually vibration free operation, with very low water resistance under sail, plus increased propulsion efficiency due to the thrust direction being parallel to the boat's waterline.



FEATURES & BENEFITS

- Installation and service made easy in comparison to conventional inboard shaft drive installations,
- Forced lubrication system, integrated oil cooling system,
- Structure made of high strength aluminium alloy with corrosion resistant protection, electrically isolated from the engine,
- Can be matched with a variety of fixed or foldable propeller configurations.



Lagoon 55 - Photo: Catherine Lagoon - Photo Nicolas Clairs





TECHNICAL CHARACTERISTICS

	SP60	
Reduction ratio	2.15 : 1	2.38 : 1
Max input power	66.6 hp [49 kW] @ 3000 rpm	59.8 hp [44 kW] @ 3600 rpm
Dry weight [kg]	35	
Oil capacity [litre]	3	
Oil type	ATF	
Propeller shaft	17 standard spline	
Propeller diameter	From 13" to 18" maxi	

OPTIONNAL SPP

- The pivoting leg, operated by a robust industrial electric motor with special marine protection, gives always the requested power in the right direction.
- Joystick maneuvering is comfortable, easy, intuitive and reliable. You can exploit your engine full power when maneuvering with just two fingers !
- It SPP comes with latest electronic technology, plug and play components and electric pre-wired parts. System status can be easily read in every moment through the LEDs lighting on the joystick.



TECHNICAL CHARACTERISTICS

	SD12	SD15
Reduction ratio	2.31 : 1	2.49 : 1
Max input power	72 hp [53 kW] @ 2700 rpm	135 hp [99.4 kW] @ 2600 rpm
Dry weight [kg]	45	100
Oil capacity [litre]	2.8	6
Oil type	SAE 15W40	ATF
Propeller shaft	16/32 standard spline	DIN 5480 W33x1.25x30x25 9d
Propeller diameter	21" maxi	23" maxi

N2.10

PROPULSION

Shaft Line

Sail Drive



PERFORMANCE DATA

Model	kW	hp	rpm	l/h	Rating
N2.10	7.36	10	3000	2.4	M5

ENGINE OVERVIEW

Configuration	2 cylinders in line 4 stroke Diesel
Fuel system	Mechanical Indirect (E-TVCS)
Displacement	0.479 l [29.2 in ³]
Bore & Stroke	67 x 68 mm [2.64 x 2.68 in]
Intake	Naturally aspirated
Cooling	Closed cooling with heat exchanger Keel Cooling (optional)
Gearbox	Shaft line or Sail Drive
Emissions	RCD2 2013/53/EU, EPA marine Tier 3, BSO 2

DIMENSIONS & WEIGHT

Max length	476 mm [18.7 in]
Length clutch	399 mm [15.7 in]
Width	428 mm [16.9 in]
Height	495 mm [19.5 in]
Dry weight	78 kg [172 lbs]

FEATURES & BENEFITS

- Kubota engine base
- Low rated rpm
- Low fuel consumption
- Gear driven valve train
- Easy routine servicing
- Class-leading package size & Weight
- Installation flexibility
- Repowering made easy
- Low installation costs

N2.14

PROPULSION

Shaft Line

Sail Drive

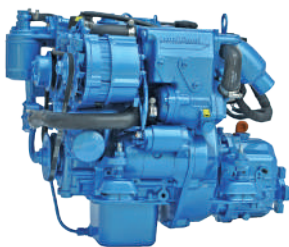

PERFORMANCE DATA

Model	kW	hp	rpm	l/h	Rating
N2.14	10.3	14	3600	3.6	M5

ENGINE OVERVIEW

Configuration	2 cylinders in line 4 stroke Diesel
Fuel system	Mechanical Indirect (E-TVCS)
Displacement	0.479 l [29.2 in ³]
Bore & Stroke	67 x 68 mm [2.64 x 2.68 in]
Intake	Naturally aspirated
Cooling	Closed cooling with heat exchanger Keel Cooling (optional)
Gearbox	Shaft line or Sail Drive
Emissions	RCD2 2013/53/EU, EPA marine Tier 3, BSO 2

DIMENSIONS & WEIGHT

Max length	510 mm [20.1 in]
Length clutch	433 mm [17.1 in]
Width	463 mm [18.2 in]
Height	506 mm [19.9 in]
Dry weight	83 kg [183 lbs]

FEATURES & BENEFITS

- Kubota engine base
- Robust design
- Low fuel consumption
- Excellent power to weight ratio
- Gear driven valve train
- Extensive range of options
- Repowering made easy
- Low installation costs
- Installation flexibility
- Easy routine servicing

N3.21

PROPULSION

Shaft Line

Sail Drive

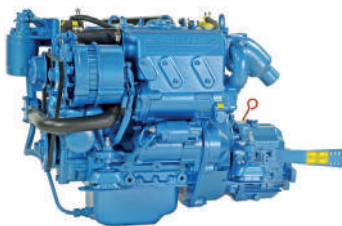

PERFORMANCE DATA

Model	kW	hp	rpm	l/h	Rating
N3.21	14.6	19.6	3600	5	M5

ENGINE OVERVIEW

Configuration	3 cylinders in line 4 stroke Diesel
Fuel system	Mechanical Indirect (E-TVCS)
Displacement	0.719 l [43.9 in ³]
Bore & Stroke	67 x 68 mm [2.64 x 2.68 in]
Intake	Naturally aspirated
Cooling	Closed cooling with heat exchanger Keel Cooling (optional)
Gearbox	Shaft line or Sail Drive
Emissions	RCD2 2013/53/EU, EPA marine Tier 3, BSO 2

DIMENSIONS & WEIGHT

Max length	578 mm [22.8 in]
Length clutch	500 mm [19.7 in]
Width	473 mm [18.6 in]
Height	506 mm [19.9 in]
Dry weight	97 kg [214 lbs]

FEATURES & BENEFITS

- Kubota engine base
- Low fuel consumption
- Installation flexibility
- Low installation costs
- Gear driven valve train
- Excellent power to weight ratio
- Extensive range of options
- Repowering kits
- Easy routine servicing

*Contact your Nanni representative for more details.

N3.30

PROPULSION

Shaft Line

Sail Drive



PERFORMANCE DATA

Model	kW	hp	rpm	l/h	Rating
N3.30	21.3	29	3600	7.4	M5

ENGINE OVERVIEW

Configuration	3 cylinders in line 4 stroke Diesel
Fuel system	Mechanical Indirect (E-TVCS)
Displacement	1.123 l [68.5 in ³]
Bore & Stroke	78 x 78.4 mm [3.07 x 3.09 in]
Intake	Naturally aspirated
Cooling	Closed cooling with heat exchanger Keel Cooling (optional)
Gearbox	Shaft line or Sail Drive
Emissions	RCD2 2013/53/EU, EPA marine Tier 3, BSO 2

DIMENSIONS & WEIGHT

Max length	667 mm [26.2 in]
Length clutch	570 mm [22.4 in]
Width	467 mm [18.39 in]
Height	589 mm [23.2 in]
Dry weight	136 kg [300 lbs]

FEATURES & BENEFITS

- Kubota engine base
- Low fuel consumption
- Gear driven valve train
- Easy routine servicing
- Repowering made easy
- Installation flexibility
- Extensive range of options
- Low installation costs
- Class-leading package size
- SOLAS approved version available

N4.38

Propulsion

Shaft Line

Sail Drive

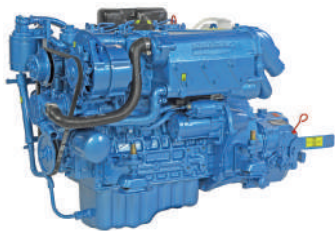

PERFORMANCE DATA

Model	kW	hp	rpm	l/h	Rating
N4.38	27.6	37.5	3000	8.7	M4

ENGINE OVERVIEW

Configuration	4 cylinders in line 4 stroke Diesel
Fuel system	Mechanical Indirect (E-TVCS)
Displacement	1.498 l [91.4 in ³]
Bore & Stroke	78 x 78.4 mm [3.07 x 3.08 in]
Intake	Naturally aspirated
Cooling	Closed cooling with heat exchanger Keel Cooling (optional)
Gearbox	Shaft line or Sail Drive
Emissions	RCD2 2013/53/EU, EPA marine Tier 3, BSO 2

DIMENSIONS & WEIGHT

Max length	749 mm [29.5 in]
Length clutch	655 mm [25.8 in]
Width	465 mm [18.3 in]
Height	605 mm [23.8 in]
Dry weight	139 kg [306 lbs]

FEATURES & BENEFITS

- Kubota engine base
- Robust design
- Low fuel consumption
- Low rated rpm
- High power density
- Installation flexibility
- Extensive range of options
- Low installation costs
- Easy routine servicing
- Gear driven valve train
- SOLAS approved version available

N4.40

Propulsion

Shaft Line

Sail Drive

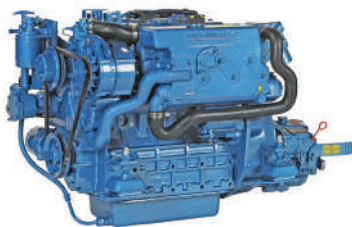

PERFORMANCE DATA

Model	kW	hp	rpm	l/h	Rating
N4.40	29.4	40	2800	9.3	M4

ENGINE OVERVIEW

Configuration	4 cylinders in line 4 stroke Diesel
Fuel system	Mechanical Indirect (E-TVCS)
Displacement	1.999 l [122 in ³]
Bore & Stroke	83 x 92.4 mm [3.26 x 3.63 in]
Intake	Naturally aspirated
Cooling	Closed cooling with heat exchanger Keel Cooling (optional)
Gearbox	Shaft line or Sail Drive
Emissions	RCD2 2013/53/EU, EPA marine Tier 3

DIMENSIONS & WEIGHT

Max length	763 mm [30 in]
Length clutch	719 mm [28.3 in]
Width	544 mm [21.4 in]
Height	623 mm [24.5 in]
Dry weight	214 kg [472 lbs]

FEATURES & BENEFITS

- Kubota engine base
- Low rated rpm
- Extensive range of options
- Low fuel consumption
- Gear driven valve train
- Installation flexibility
- Repowering made easy
- Low installation costs
- Easy routine servicing

N4.50

Propulsion

Shaft Line

Sail Drive

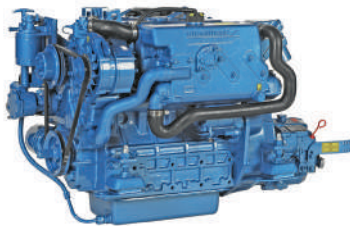

PERFORMANCE DATA

Model	kW	hp	rpm	l/h	Rating
N4.50	35.4	47.5	2800	11.7	M4

ENGINE OVERVIEW

Configuration	4 cylinders in line 4 stroke Diesel
Fuel system	Mechanical Indirect (E-TVCS)
Displacement	2.197 l [134.1 in ³]
Bore & Stroke	87 x 92.4 mm [3.43 x 3.63 in]
Intake	Naturally aspirated
Cooling	Closed cooling with heat exchanger Keel Cooling (optional)
Gearbox	Shaft line or Sail Drive
Emissions	RCD2 2013/53/EU, EPA marine Tier 3, BSO 2

DIMENSIONS & WEIGHT

Max length	763 mm [30 in]
Length clutch	719 mm [28.3 in]
Width	544 mm [21.4 in]
Height	623 mm [24.5 in]
Dry weight	216 kg [476.2 lbs]

FEATURES & BENEFITS

- Kubota engine base
- Robust design
- Low fuel consumption
- Low rated rpm
- High power density
- Installation flexibility
- Extensive range of options
- Low installation costs
- Easy routine servicing
- Gear driven valve train
- SOLAS approved version available

N4.65

Propulsion

Shaft Line

Sail Drive



PERFORMANCE DATA

Model	kW	hp	rpm	l/h	Rating
N4.65	43.4	59	2700	13.5	M4

ENGINE OVERVIEW

Configuration	4 cylinders in line 4 stroke Diesel
Fuel system	Mechanical Indirect (E-TVCS)
Displacement	2.434 l [148.5 in ³]
Bore & Stroke	87 x 102.4 mm [3.43 x 4.03 in]
Intake	Turbocharged
Cooling	Closed cooling with heat exchanger Keel Cooling (optional)
Gearbox	Shaft line or Sail Drive
Emission	RCD2 2013/53/EU, EPA marine Tier 3, BSO 2

DIMENSIONS & WEIGHT

Max length	732 mm [28.8 in]
Length clutch	697 mm [27.4 in]
Width	505 mm [19.9 in]
Height	632 mm [24.9 in]
Dry weight	248 kg [546.75 lbs]

FEATURES & BENEFITS

- Kubota engine base
- Class-leading package size
- High power density
- Extensive range of options
- Low fuel consumption
- Repowering made easy
- Low installation costs
- Gear driven valve train
- Easy routine servicing
- SOLAS approved version available
- Installation flexibility

N4.80

Propulsion

Shaft Line

Sail Drive



PERFORMANCE DATA

Model	kW	hp	rpm	l/h	Rating
N4.80	57.4	79	2700	15.6	M5
N4.80 SD	52.9	72	2700	14.4	M5

ENGINE OVERVIEW

Configuration	4 cylinders in line 4 stroke Diesel
Fuel system	Mechanical Indirect (E-TVCS)
Displacement	2.434 l [148.5 in ³]
Bore & Stroke	87 x 102.4 mm [3.43 x 4.03 in]
Intake	Turbocharged & Intercooler
Cooling	Closed cooling with heat exchanger Keel Cooling (optional)
Gearbox	Shaft line or Sail Drive
Emission	RCD2 2013/53/EU, EPA marine Tier 3, BSO 2

DIMENSIONS & WEIGHT

Compliances underway

Max length	898 mm [35.35 in]
Width	545 mm [21.45 in]
Height	664 mm [26.14 in]
Dry weight	258 kg [568.8 lbs]

FEATURES & BENEFITS

- Kubota engine base
- Class-leading package size
- High power density
- Extensive range of options
- Low fuel consumption
- Repowering made easy
- Low installation costs
- Gear driven valve train
- Easy routine servicing
- SOLAS approved version available
- Installation flexibility

N4.115/140

Propulsion

Shaft Line

Sail Drive*

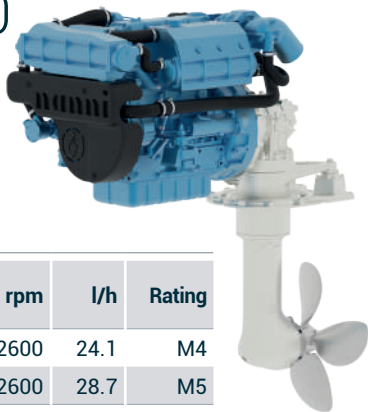

PERFORMANCE DATA

Model	kW	hp	rpm	l/h	Rating
N4.115	84.6	115	2600	24.1	M4
N4.140	99.4	135	2600	28.7	M5

ENGINE OVERVIEW

Configuration	4 cylinders in line 4 stroke Diesel
Fuel system	Mechanical Direct (E-CDIS)
Displacement	3.769 l [230 in ³]
Bore & Stroke	100 x 120 mm [3.93 x 4.72 in]
Intake	Turbocharged & Intercooler
Cooling	Closed cooling with heat exchanger Keel Cooling (optional)
Gearbox	Shaft line or Sail drive
Emissions	RCD2 2013/53/EU, EPA marine Tier 3, BSO 2

DIMENSIONS & WEIGHT

Max length	960 mm [37.8 in]
Length clutch	796 mm [31.3 in]
Width	580 mm [22.8 in]
Height	728 mm [28.7 in]
Dry weight	350 kg [772 lbs]

FEATURES & BENEFITS

- Kubota engine base
- Low rated rpm
- Installation flexibility
- Low installation costs
- Easy routine servicing
- Gear driven valve train
- Extensive range of options

* N4.115 only

STERN DRIVE PROPULSION SYSTEM

One of the most efficient propulsion systems designed for pleasure planing boat. Combining the best of both worlds, the Stern Drive propulsion system brings inboard reliability together with outboard convenience and space saving.

This system offers boat builders increased design flexibility, more versatility in engine placement and a smaller footprint.

For boat owners, it results in more efficient thrust under power, thanks to the propeller shaft being parallel to the boat's waterline.

As a marine propulsion specialist, Nanni provides an optimal package combining our engines renowned reliability along with **Bravo X One, Bravo X Two** or **Bravo X Three** Stern-Drives.



FEATURES & BENEFITS

- Ease of installation
- Integrated exhaust system
- Power trim and Power Steering
- Clutch assembly for effortless gear shifting
- Excellent manoeuvrability
- Outperforming a shaft line engine at equal power level
- Mercathode system for protection against galvanic corrosion
- Counter-rotating propeller on twin engine installation
- Aluminium or stainless steel propeller

BRAVO MODEL SELECTION

Each drive has its own characteristics and has been designed for a specific application.

Bravo X One

- Designed for high speed boats
- Small gearcase for high hydrodynamic performance
- Maximum propeller diameter 16"

Bravo X Two

- Intended for heavier & slower applications
- Larger gearcase for use of a 20" diameter propeller
- Heavy duty gearcase shafts, bearings and gears

Bravo X Three

- Counter-rotating propellers, designed for outstanding acceleration

Boat top speed is a critical parameter when choosing an appropriate Bravo model. As a reference, refer to the graph below when selecting a Bravo model.

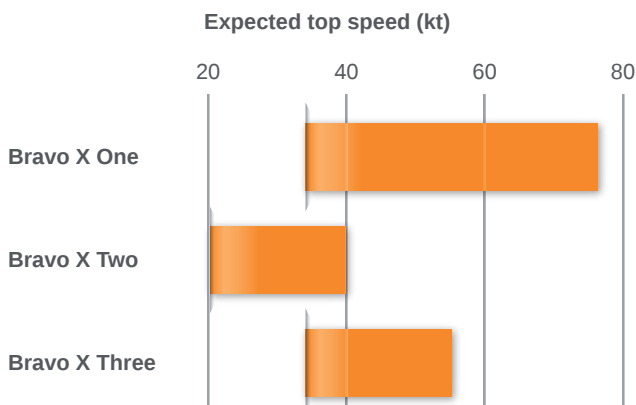

As for any propulsion system, contact Nanni for further assistance when selecting a Stern Drive model and its reduction ratio.

T4 SERIES

Propulsion

Shaft Line

Stern Drive

Water Jet



PERFORMANCE DATA

Model	kW	hp	rpm	l/h	Rating
T4.205	147.2	200	3600	40.7	M6
T4.230	169.1	230	3600	46.7	M6
T4.270	194.9	265	3600	53.6	M6

ENGINE OVERVIEW

Configuration	4 cylinders in line 4 stroke Diesel
Fuel system	Common Rail Direct injection
Displacement	2.982 l [182 in ³]
Bore & Stroke	96 x 103 mm [3.78 x 4.06 in]
Intake	Turbocharged & Intercooler
Cooling	Closed cooling with heat exchanger
Gearbox	Shaft line, Stern Drive or Water jet
Emissions	IMO Annex VI compliant, RCD2 2013/53/EU, EPA marine Tier 3, BSO 2

DIMENSIONS & WEIGHT

Max length	1042 mm [41 in]
Length clutch	800 mm [31.5 in]
Width	702 mm [27.6 in]
Height	738 mm [29 in]
Dry weight	350 kg [771.6 lbs]

FEATURES & BENEFITS

- Toyota engine base
- Robust design
- Compact package
- High power density
- Easy routine servicing
- Installation flexibility
- 4 valves per cylinder
- 2 balancing shafts



6.420 TDI

Propulsion

Shaft Line

Stern Drive

Water Jet



PERFORMANCE DATA

Model	kW	hp	rpm	l/h	Rating
6.420 TDI	235.5	320	3600	65.7	M6

ENGINE OVERVIEW

Configuration	6 cylinders in line 4 stroke Diesel
Fuel system	Mechanical Direct injection
Displacement	4.2 l [254 in ³]
Bore & Stroke	94 x 100 mm [3.7 x 3.94 in]
Intake	Turbocharged & Intercooler
Cooling	Closed cooling with heat exchanger
Gearbox	Shaft line, Stern Drive or Water jet
Emissions	BSO 2

DIMENSIONS & WEIGHT

Max length	1242 mm [48.9 in]
Length clutch	989 mm [38.9 in]
Width	669 mm [26.3 in]
Height	756 mm [29.8 in]
Dry weight	426 kg [940 lbs]

FEATURES & BENEFITS

- Toyota engine base
- Robust design
- Compact package
- High power density
- Easy routine servicing
- Installation flexibility
- 4 valves per cylinder
- Balancing shafts

T8V SERIES

Propulsion

Shaft Line

Water Jet



PERFORMANCE DATA

Model	kW	hp	rpm	l/h	Rating
T8V.320	235	320	3800	40.7	M6
T8V.350	257	350	3800	46.7	M6
T8V.370	272	370	3800	53.6	M6

ENGINE OVERVIEW

Configuration	8 cylinders V design 90° 4 stroke Diesel
Fuel system	Common Rail Direct injection
Displacement	4.5 l [275 in ³]
Bore & Stroke	86 x 96 mm [3.39 x 3.78 in]
Intake	Twin turbocharger & Intercooler
Cooling	Closed cooling with heat exchanger
Gearbox	Shaft line or Water jet
Emissions	IMO Annex VI compliant, RCD2 2013/53/EU, EPA marine Tier 3

DIMENSIONS & WEIGHT

Max length	1389 mm [54.6 in]
Length clutch	1032 mm [40.6 in]
Width	841 mm [33.1 in]
Height	756 mm [29 in]
Dry weight	435 kg [959 lbs]

FEATURES & BENEFITS

- Toyota engine base
- Robust design
- Compact package
- High power density
- Easy routine servicing
- Installation flexibility
- 4 valves per cylinder
- Internal balancers

N5 SERIES

Propulsion

Shaft Line

Water Jet



PERFORMANCE DATA

Model	kW	hp	rpm	Rating	Emissions
N5.150	112	152	2600	M4	n/a
N5.160 CR2	119	162	2300	M1	1, 4
N5.180 CR2	134	182	2400	M2	1, 4
N5.200 CR2	149	202	2500	M3	1, 4
N5.230 CR2	168	228	2600	M4	1, 4

ENGINE OVERVIEW

Configuration	4 cylinders in line 4 stroke Diesel
Fuel system *	Mechanical direct injection Common Rail Direct injection (<i>CR models</i>)
Displacement	4.5 l [276 in ³]
Bore & Stroke	106 x 127 mm [4.17 x 5.00 in]
Intake *	Turbocharged Turbo with air-to-coolant aftercooling
Cooling	Closed cooling with heat exchanger Keel Cooling (optional)
Gearbox *	Shaft line or Water jet
Emissions * (<i>CR models</i>)	IMO MARPOL Annex VI compliant, EPA Marine Tier 3

FEATURES & BENEFITS

- John Deere engine base
- Robust design
- High power density
- Internal balancers
- Easy routine servicing
- Installation flexibility
- Replaceable wet-type cylinder liners

* Depending version. Refer to specific leaflet for more informations.



Lagoon SEVENTY 7 - Photo Nicolas Claris

N6 SILVER SERIES

Propulsion

Shaft Line	Surface Drive
Water Jet	



PERFORMANCE DATA

Model	kW	hp	rpm	Rating	Emissions
N6.160	115	156	2300	M1	n/a
N6.180	131	177	2400	M2	n/a
N6.200	149	202	2500	M3	n/a
N6.230	168	228	2600	M4	n/a
N6.250 CR2	186	250	2400	M1	1, 4
N6.285 CR2	209	284	2500	M2	1, 4
N6.325 CR2	239	325	2600	M3	1, 4
N6.360 CR2	265	360	2700	M4	1, 4
N6.405 CR2	298	405	2800	M5	1, 4

ENGINE OVERVIEW

Configuration	6 cylinders in line 4 stroke Diesel
Fuel system *	Mechanical direct injection Common Rail Direct injection (<i>CR models</i>)
Displacement	6.8 l [415 in ³]
Bore & Stroke	106 x 127 mm [4.17 x 5.00 in]
Intake *	Turbocharged Turbocharged with air-to-coolant aftercooling
Cooling	Closed cooling with heat exchanger Keel Cooling (optional)
Gearbox *	Shaft line, Water jet, Surface drive
Emissions * (CR models)	IMO MARPOL Annex VI compliant, EPA Marine Tier 3

FEATURES & BENEFITS

- John Deere engine base
- High power density
- Robust design
- Replaceable wet-type cylinder liners
- Installation flexibility

* Depending version. Refer to specific leaflet for more informations.

N9 SILVER SERIES

Propulsion

Shaft Line

Surface Drive

Water Jet



PERFORMANCE DATA

Model	kW	hp	rpm	Rating	Emissions
N9.330 CR2	242	329	2100	M1	1, 4
N9.380 CR2	280	380	2200	M2	1, 4
N9.430 CR2	317	431	2300	M3	1, 2, 4
N9.510 CR2	373	507	2400	M4	1, 2, 4
N9.600 CR2	410	557	2500	M5	1, 2, 4

ENGINE OVERVIEW

Configuration	6 cylinders in line 4 stroke Diesel
Fuel system	Common Rail Direct injection
Displacement	9.0 l [549 in ³]
Bore & Stroke	118.4 x 136 mm [4.66 x 5.35 in]
Intake	Turbocharged with air-to-seawater aftercooling
Cooling	Closed cooling with heat exchanger Keel Cooling (optional)
Gearbox *	Shaft line, Water jet, Surface drive
Emissions *	IMO MARPOL Annex VI compliant, EPA Marine Tier 3

FEATURES & BENEFITS

- John Deere engine base
- Robust design
- High power density
- 4 valves per cylinder
- Easy routine servicing
- Installation flexibility
- Replaceable wet-type cylinder liners

* Depending version. Refer to specific leaflet for more informations.



N13 SILVER SERIES

Propulsion



Shaft Line

Surface Drive

Water Jet

PERFORMANCE DATA

Model	kW	hp	rpm	Rating	Emissions
N13.430 CR2	317	431	1800	M1	1, 2, 4
N13.510 CR2	373	507	1900	M2	1, 2, 4
N13.580 CR2	429	583	2000	M3	1, 2, 4
N13.660 CR2	485	659	2100	M4	1, 2, 4
N13.800 CR2	559	760	2200	M5	1, 2, 4

ENGINE OVERVIEW

Configuration	6 cylinders in line 4 stroke Diesel
Fuel system	Electronically controlled unit injectors
Displacement	13.5 l [824 in ³]
Bore & Stroke	132 x 165 mm [5.20 x 6.50 in]
Intake	Turbocharged with air-to-seawater aftercooling
Cooling	Closed cooling with heat exchanger Keel Cooling (optional)
Gearbox *	Shaft line, Water jet, Surface drive
Emissions *	IMO MARPOL Annex VI compliant, EPA Marine Tier 3

FEATURES & BENEFITS

- John Deere engine base
- Robust design
- High power density
- 4 valves per cylinder
- Installation flexibility
- Replaceable wet-type cylinder liners

* Depending version. Refer to specific leaflet for more informations.



N13 PLATINUM SERIES

Propulsion

Shaft Line	Surface Drive
Water Jet	

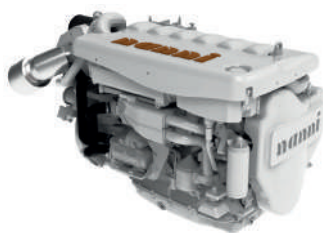

PERFORMANCE DATA

Model	kW	hp	rpm	Rating	Emissions
N13.700 CR3	515	700	2300	M5.L M6.S	1, 2, 4
N13.750 CR3	552	751	2300	M5.L M6.S	1, 2, 4
N13.800 CR3	588	800	2300	M5.L M6.S	1, 2, 4
N13.900 CR3	662	900	2300	M6.S	1, 2, 4
N13.930 CR3	680	925	2300	M6.S	1, 2

ENGINE OVERVIEW

Configuration	6 cylinders in cylinders 4 stroke Diesel
Fuel system	Common Rail Direct Injection Extra High Pressure (XPI)
Displacement	12.7 l [775 in ³]
Bore & Stroke	130 x 160 mm [5.1 x 6.3 in]
Intake	Turbocharged with after cooler
Cooling	Closed cooling with heat exchanger and charge air cooler Keel Cooling (optional)
Gearbox *	Shaft line, Water jet, Surface drive
Emissions *	US Tier 3, IMO Tier II, RCD2, ok for RCD2 2013/53/EU and CCNR2

FEATURES & BENEFITS

- Scania engine base
- High power density
- Robust design
- High torque at low RPM
- Optimized fuel consumption at maximum torque
- Replaceable wet-type cylinder liners
- Installation flexibility
- Best in class on power to weight Ratio

* Depending version. Refer to specific leaflet for more informations.

N16 PLATINUM SERIES

Propulsion

Shaft Line	Surface Drive
Water Jet	



PERFORMANCE DATA

Model	kW	hp	rpm	Rating	Emissions
N16.900 CR3	662	900	2300	M1.S	1, 2
N16.1000 CR3	736	1000	2300	M6.S	1, 2
N16.1100 CR3	809	1100	2300	M6.S	1, 2
N16.1150 CR3	846	1150	2300	M6.S	1, 2
N16.1200 CR3	882	1200	2300	M6.S	1

ENGINE OVERVIEW

Configuration	8 cylinders in V 4 stroke Diesel
Fuel system	Common Rail Direct Injection Extra High Pressure (XPI)
Displacement	16.4 l [1000.5 in ³]
Bore & Stroke	130 x 154 mm [5.1 x 6.1 in]
Intake	Turbocharged with after cooler
Cooling	Closed cooling with heat exchanger and charge air cooler Keel Cooling (optional)
Gearbox *	Shaft line, Water jet, Surface drive
Emissions *	IMO Tier II, ok for RCD2 2013/53/EU and CCNR2

FEATURES & BENEFITS

- Scania engine base
- High power density
- Robust design
- High torque at low RPM
- Optimized fuel consumption at maximum torque
- Replaceable wet-type cylinder liners
- Installation flexibility
- Best in class on power to weight Ratio

* Depending upon version. Refer to specific leaflet for more informations.

Dimensions & Weight for N5 / N6 / N9 / N13 / N16 series

Engine	Engine length *	Width mm [in]	Height mm [in]	Weight kg [lb]
N5.150	885 [34.8]	712 [28.0]	912 [35.9]	462 [1017]
N5.160 CR2	885 [34.8]	770 [30.3]	964 [37.9]	578 [1274]
N5.180 CR2	885 [34.8]	770 [30.3]	964 [37.9]	578 [1274]
N5.200 CR2	885 [34.8]	770 [30.3]	964 [37.9]	578 [1274]
N5.230 CR2	885 [34.8]	770 [30.3]	964 [37.9]	578 [1274]
N6.160	1152 [45.3]	883 [34.8]	884 [34.8]	735 [1620]
N6.180	1152 [45.3]	883 [34.8]	884 [34.8]	735 [1620]
N6.200	1152 [45.3]	883 [34.8]	884 [34.8]	735 [1620]
N6.230	1152 [45.3]	883 [34.8]	884 [34.8]	735 [1620]
N6.250 CR2	1152 [45.3]	883 [34.8]	884 [34.8]	735 [1620]
N6.285 CR2	1152 [45.3]	883 [34.8]	884 [34.8]	735 [1620]
N6.325 CR2	1152 [45.3]	883 [34.8]	884 [34.8]	735 [1620]
N6.360 CR2	1152 [45.3]	883 [34.8]	884 [34.8]	735 [1620]
N6.405 CR2	1152 [45.3]	883 [34.8]	884 [34.8]	735 [1620]
N9.330 CR2	1228 [48.3]	840 [33.0]	951 [37.4]	948 [2090]
N9.380 CR2	1228 [48.3]	840 [33.0]	951 [37.4]	948 [2090]
N9.430 CR2	1228 [48.3]	840 [33.0]	951 [37.4]	948 [2090]
N9.510 CR2	1228 [48.3]	840 [33.0]	951 [37.4]	948 [2090]
N9.600 CR2	1228 [48.3]	840 [33.0]	951 [37.4]	948 [2090]
N13.430 CR2	1426 [56.1]	1032 [40.6]	1143 [45]	1380 [3042]
N13.510 CR2	1426 [56.1]	1032 [40.6]	1143 [45]	1380 [3042]
N13.580 CR2	1426 [56.1]	1032 [40.6]	1143 [45]	1380 [3042]
N13.660 CR2	1426 [56.1]	1032 [40.6]	1143 [45]	1380 [3042]
N13.800 CR2	1426 [56.1]	1032 [40.6]	1143 [45]	1380 [3042]
N13.700 CR3	1389 [54.7]	1073 [42.2]	1115 [43,9]	1285 [2833]
N13.750 CR3	1389 [54.7]	1073 [42.2]	1115 [43,9]	1285 [2833]
N13.800 CR3	1389 [54.7]	1073 [42.2]	1115 [43,9]	1285 [2833]
N13.900 CR3	1389 [54.7]	1073 [42.2]	1115 [43,9]	1285 [2833]
N13.930 CR3	1389 [54.7]	1073 [42.2]	1115 [43,9]	1285 [2833]
N16.900 CR3	1362 [53.6]	1278 [50,3]	1136 [44,7]	1660 [3659]
N16.1000 CR3	1362 [53.6]	1278 [50,3]	1136 [44,7]	1660 [3659]
N16.1100 CR3	1362 [53.6]	1278 [50,3]	1136 [44,7]	1660 [3659]
N16.1150 CR3	1362 [53.6]	1278 [50,3]	1136 [44,7]	1660 [3659]
N16.1200 CR3	1362 [53.6]	1278 [50,3]	1136 [44,7]	1660 [3659]

* From front end to edge of flywheel housing mm [in]

MAREX CONTROL & MONITORING SYSTEMS

FULL CONTROL FOR ANY TYPE OF VESSEL.
UNRIVALLED MODULARITY LEVEL

As an experienced marine equipment manufacturer, we offer solutions and products such as remote controls, joysticks, ship monitoring and alarm systems. You can take advantage of configuration, parameterization, delivery and commissioning from a single source.

Installation are made easy thanks to the systems modular architecture. We can rapidly determine the required functions and adapt each system to the vessel specific requirements. Both, basic components as well as operating and control modules are quickly coordinated and programmed.

CONTROL SYSTEMS

The remote control systems are perfectly tailored to diverse requirements for virtually every type of propulsion and ship, including work vessels with classification, passenger liners and yachts. Whether electronic or electro-mechanical control, the modular system design allows a flexible configuration while easing installation and configuration.

ALARM & MONITORING SYSTEMS

Ship alarm and monitoring systems provide structured and clear access to the vast information and functions provided by the different systems on board.

This powerful marine instrument features a clearly arranged, user-friendly design. This permits prompt signaling of safety-related operational data such as overspeed and loss of oil pressure. You can also monitor all operating conditions and operate many systems centrally or automate their control.

MAREX OS III

DESIGNED TO KEEP THE COURSE

The Marex OS III ensures effective control and can be installed in ships with classic reversing gears, jet propulsions and controllable propellers.

The hardware of the Marex OS III consists of only a few modular units that are extremely powerful thanks to their bus connection.

All components are ready to connect, which simplifies the installation in new buildings and retrofits.



All components correspond to the highest demands of safety and fulfill the requirements of the most important classification societies.

KEY FEATURES & ADVANTAGES

- Multi-engine systems
- Engine control, speed curves and engine stall protection
- Gear operation, reversing maneuver curves
- Bridge components can also be used in the outside area
- Various control head designs
- Dynamic, asymmetric levers
- Integrated keypad
- Easy installation thanks to pre-assembly
- Approval of drawing and FAT upon request

MAREX ECS

THE EASY CONTROL SYSTEM



The Marex ECS (Easy Control System) is designed for both recreational and work boats.

Easy to operate, unique design, universal possibilities. The Marex ECS meets the highest production and quality standards, with endurance testing of one million lever actuations.

Its hardware comes from proven automotive applications with reliable CAN bus technology, and a self-diagnosis system that sends any alarm to the system. It also provides easy handling resulting in reduced installation and commissioning efforts and uncomplicated operation features.

The enhanced version features a separate backup Hall sensor which makes it even more reliable and safe. The control of the boat will be maintained, even if CAN communication is interrupted.

KEY FEATURES & ADVANTAGES

- Exclusive chrome surfaces, contrasted with black
- Language-independent icons
- Subtle backlight illumination
- Dynamic, asymmetric levers
- ABYC compliant system
- Plug-and-play connections for ease of installation
- Auto-configuration

JOYSTICK MANOEUVRING SYSTEM

MANOEUVRING WITH EASE

The Joystick Manoeuvring system provides the helmsman with simple and intuitive boat control. The operator moves the joystick and the ship mirrors the movement exactly. The controller automatically compensates for external influences, such as wind or current.



Functional and room-saving, both the joystick and its operating module provides essential functions to operate. The joystick can be used as a separate control element (stand-alone solution) or combined with a control head at a station (pairing). Further functions, such as direct thruster actuation in thruster mode, provide operating comfort and reliability.

KEY FEATURES & ADVANTAGES

- Modern, ergonomic design
- Intuitive operation
- Direction compensation
- Flexible interface
- Plus-and-play installation
- Configuration, parameterization, delivery, and commissioning from a single source

INTERACTIVE CONTROL DISPLAYS

UNPRECEDENTED COMFORT

New innovative dependable Nanni interactive control displays are the ultimate solution for all marine situations.

While being the most tiny of all controllers (170 x 104 mm), the SI.4 will replace a dozen of analog gauges.

SI.4



Powerful, intuitive, interactive and reliable, these new monitoring and control systems are included in the accessory range of Nanni to provide all over the world, a complete engine package of high quality for professional applications and for pleasure.

INTUITIVE AND POWERFUL

SI.7 & SI.9



SI.7 and SI.9 – the powerful new multifunction navigation systems from Nanni. With available built-in RealVision 3D™ sonar, the all new LightHouse 3 operating system, and blazing fast quad core performance, SI.7 and SI.9 will transform your time on the water.

SI.7 and SI.9 are expandable so their capabilities can grow as needed.



ACCESSORIES OPTIONS

- Chart application
- Weather mode
- CHIRP Sonar (Realvision 3D)
- Radar application
- Dashboard application
- Camera application
- Audio application
- Mobile application

SI.19 Ultra Wide display



KEY FEATURES & ADVANTAGES

- Survey of all engine parameters - multi alarms systems
- Ultimate engine control, speed curves and engine protection
- Available for engines from 21 to 2000 hp
- Hassle free installation thanks to harness pre-assembly



GENERATOR SETS

The generator set range covers a power range from 6 kW to 500 kW. All generator sets are delivered assembled and ready for installation. As always, Nanni is able to provide all installation related equipment, from fuel tank to exhaust system.

QMF series

Designed specifically for pleasure duty applications, generators sets of the QMF series come as standard with a sound attenuated enclosure. Both the engine and the alternator are water-cooled, ensuring a maximal life span and smooth functioning.

QMS series

Alternators used in the QMS range are manufactured by Mecc Alte, a world leader in the production of compact synchronous alternators. Most generator sets of the QMS series are available with an optional sound enclosure.

On both the QMF and QMS range, the sound enclosure is made of insulated panels in painted marine aluminium. with multiple access ports for all necessary connections and maintenance items including lifting visual access.

QLS series

The QLS generator range comes with Leroy Somer alternators, internationally renowned for built-in quality, reliability and versatility. As well as providing quiet, dependable power for pleasure duty applications, these generator sets are also perfectly suitable for continuous duty applications.

GENERATOR SET RANGE

MODEL		kW*		OUTPUT VOLTS		PAGE	
50Hz	60Hz	50Hz	60Hz	50Hz	60Hz	50Hz	60Hz
QMF 6M	n/a	5	n/a	230	n/a	53	n/a
QMS 7.5M	QMS 9M60 ¹	7.5	9.1	230	120	54	58
QMS 10M	QMS 12M60 ¹	10	12	230	120-240	54	58
QMS 16M	QMS 20M60	16.2	19.6	230	120-240	54	59
QMS 25M	n/a	22.9	n/a	230	n/a	54	n/a
QMS 35M	n/a	34.7	n/a	230	n/a	55	n/a
QMS 10T	QMS 12T60 ¹	7.7	9.4	230-400	120-240	55	59
QMS 13T	QMS 16T60 ¹	10.2	12.4	230-400	120-240	55	59
QMS 21T	QMS 25T60	16.7	20.2	230-400	120-240	55	59
QMS 32T	n/a	24.3	n/a	230-400	n/a	55	n/a
QMS 35M	n/a	34.7	n/a	230	n/a	55	n/a
QMS 46T	n/a	36.7	n/a	230-400	n/a	55	n/a
QLS 10T	QLS 12T60 ¹	7.9	9.9	230-400	120-240	56	60
QLS 13T	QLS 16T60 ¹	10.7	13.1	230-400	120-240	56	60
QLS 22T	QLS 27T60	17.7	21.4	230-400	120-240	56	61
QLS 32T	n/a	25.7	n/a	230-400	n/a	57	n/a
QLS 38M	n/a	37.5	n/a	230	n/a	57	n/a
QLS 47T	n/a	37.8	n/a	400	n/a	57	n/a
QLS 65T	n/a	53.7	n/a	400	n/a	57	n/a
QLS 70T ²	n/a	56	n/a	400		57	n/a
QLS 102T	n/a	84.6	n/a	400	n/a	57	n/a
QLS135T ²	n/a	108	n/a	400		57	n/a
n/a	QLS 115T60	n/a	107	n/a	480	n/a	61

* Prim Power according to ISO 8528-1

¹ EPA Tier 3

² EU Regulation 2016/1628 NRMM Stage V

For gensets above QLS 102T, Please contact your nearest Nanni representative.

QMF SERIES

50 Hz Generator Sets



	Model	QMF 6M
Configuration		2 cylinders in line
Engine base		Kubota
Fuel system		Mechanical
Injection system		Indirect
Intake		Naturally aspirated
Displacement	L [in ³]	0.479 [29.2]
Rated speed	rpm	3000
GENERATOR RATINGS		
Frequency	Hz	50
Continuous power	kW [kVA]	4.6 [4.6]
Prime power	kW [kVA]	5 [5]
Voltage	V	230
Phase		1
Power factor		1
DIMENSIONS & WEIGHT		
Length	mm [in]	650 [25.9]
Width	mm [in]	480 [18.9]
Height	mm [in]	530 [20.9]
Dry weight	kg [lbs]	128 [282]

QMS SERIES

50Hz Generator Sets



	Model	QMS 7.5M	QMS 10M	QMS 16M	QMS 25M
Configuration		3 cylinders in line	4 cylinders in line	4 cylinders in line	4 cylinders in line
Engine base		Kubota	Kubota	Kubota	Kubota
Fuel system		Mechanical	Mechanical	Mechanical	Mechanical
Injection system		Indirect	Indirect	Indirect	Indirect
Intake		Naturally aspirated	Naturally aspirated	Naturally aspirated	Naturally aspirated
Displacement	L [in ³]	1.1 [68.5]	1.5 [91.4]	2.2 [134]	3.3 [202.5]
Rated speed	rpm	1500	1500	1500	1500
Sound Shield option		✓	✓	✓	✓
GENERATOR RATINGS					
Frequency	Hz	50	50	50	50
Cont power	kW [kVA]	6.6 [6.6]	8.8 [8.8]	13.9 [13.9]	20.8 [20.8]
Prime power	kW [kVA]	7.5 [7.5]	10 [10]	16.2 [16.2]	22.9 [22.9]
Voltage	V	230	230	230	230
Phase		1	1	1	1
Power factor		1	1	1	1
DIMENSIONS WITHOUT SOUND ENCLOSURE					
Length	mm [in]	840 [33.1]	925 [36.4]	1014 [39.9]	1304 [51.3]
Width	mm [in]	489 [19.2]	489 [19.2]	548 [21.6]	636 [25]
Height	mm [in]	620 [24.4]	620 [24.4]	691 [27.2]	766 [30.1]
Dry weight	kg [lbs]	224 [494]	244 [538]	328 [723]	378 [833]
DIMENSIONS WITH SOUND ENCLOSURE					
Length	mm [in]	950 [37.4]	1050 [41.3]	1130 [44.5]	1590 [62.6]
Width	mm [in]	540 [21.3]	540 [21.3]	600 [23.6]	700 [27.5]
Height	mm [in]	710 [28]	710 [28]	700 [27.6]	900 [35.4]
Dry weight	kg [lbs]	271 [598]	291 [641]	378 [833]	550 [1213]



QMS 35M	QMS 10T	QMS 13T	QMS 21T	QMS 32T	QMS 46T
4 cylinders in line	3 cylinders in line	4 cylinders in line	4 cylinders in line	4 cylinders in line	4 cylinders in line
Kubota	Kubota	Kubota	Kubota	Kubota	Kubota
Mechanical	Mechanical	Mechanical	Mechanical	Mechanical	Mechanical
Indirect	Indirect	Indirect	Indirect	Indirect	Direct
Turbo-charged	Naturally aspirated	Naturally aspirated	Naturally aspirated	Naturally aspirated	Turbo-charged
3.8 [230]	1.1 [68.5]	1.5 [91.4]	2.2 [134]	3.3 [202.5]	3.8 [230]
1500	1500	1500	1500	1500	1500
✓	✓	✓	✓	✓	✓
50	50	50	50	50	50
32 [32]	6.8 [8.5]	9.1 [11.4]	14.3 [17.9]	22.1 [27.6]	33.7 [42.1]
34.7 [34.7]	7.7 [9.6]	10.2 [12.8]	16.7 [20.9]	24.3 [30.4]	36.7 [45.9]
230	230-400	230-400	230-400	230-400	230-400
1	3	3	3	3	3
1	0.8	0.8	0.8	0.8	0.8
1394 [54.9]	840 [33.1]	925 [36.4]	1014 [39.9]	1304 [51.3]	1394 [54.9]
644 [25.4]	489 [19.2]	489 [19.2]	548 [21.6]	636 [25]	644 [25.4]
792 [31.2]	620 [24.4]	620 [24.4]	691 [27.2]	766 [30.1]	792 [31.2]
398 [877]	224 [494]	244 [538]	328 [723]	378 [833]	398 [877]
1590 [62.6]	950 [37.4]	1050 [41.3]	1130 [44.5]	1590 [62.6]	1590 [62.6]
700 [27.6]	540 [21.3]	540 [21.3]	600 [23.6]	700 [27.6]	700 [27.6]
900 [35.4]	710 [28]	710 [28]	700 [27.6]	900 [35.4]	900 [35.4]
570 [1257]	271 [598]	291 [641]	378 [833]	550 [1213]	570 [1257]

QLS SERIES

50 Hz Generator Sets

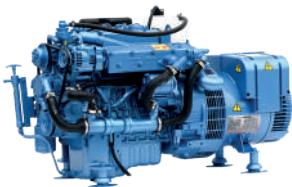

Model		QLS 10T	QLS 13T	QLS 22T	QLS32T
Configuration		3 cylinders in line	4 cylinders in line	4 cylinders in line	4 cylinders in line
Engine base		Kubota	Kubota	Kubota	Kubota
Fuel system		Mechanical	Mechanical	Mechanical	Mechanical
Injection system		Indirect	Indirect	Indirect	Indirect
Air intake		Naturally aspirated	Naturally aspirated	Naturally aspirated	Naturally aspirated
Displacement	L [in ³]	1.1 [68.5]	1.5 [91.4]	2.2 [134]	3.3 [202.5]
Rated speed	rpm	1500	1500	1500	1500
GENERATOR RATINGS					
Frequency	Hz	50	50	50	50
Cont. power	kW [kVA]	7 [8.8]	9.5 [11.9]	15.1 [18.9]	23.4 [29.2]
Prime power	kW [kVA]	7.9 [9.9]	10.7 [13.4]	17.7 [22.1]	25.7 [32.1]
Voltage	V	400	400	400	400
Phase		3	3	3	3
Power factor		0.8	0.8	0.8	0.8
DIMENSIONS					
Length	mm [in]	959 [37.8]	1081 [42.5]	1167 [46.6]	1304 [51.3]
Width	mm [in]	489 [19.3]	486 [19.1]	548 [21.6]	636 [25]
Height	mm [in]	624 [24.6]	620 [24.4]	692 [27.2]	814 [32]
Dry weight	kg [lbs]	251 [553]	264 [582]	360 [794]	550 [1213]



QLS 38M	QLS 47T	QLS 65T	QLS70T	QLS 102T	QLS135T
4 cylinders in line	4 cylinders in line	4 cylinders in line	4 cylinders in line	6 cylinders in line	6 cylinders in line
Kubota	Kubota	John Deere	John Deere	John Deere	John Deere
Mechanical	Mechanical	Mechanical	CR	Mechanical	CR
Direct	Direct	Direct	Direct	Direct	Direct
Turbo	Turbo	Turbo	Turbo	Turbo	Turbo
3.8 [230]	3.8 [230]	4.5 [276]	4.5 [276]	6.8 [414]	6.8 [414]
1500	1500	1500	1500	1500	1500
50	50	50	50	50	50
34.5 [34.5]	34.4 [43]	37.5 [45.8]	40.1 [49]	59 [72]	113.3 [92.7]
37.5 [37.5]	37.8 [47.2]	53.7 [65.4]	56 [69.9]	84.6 [102.6]	108 [135]
230	400	400	400	400	400
1	3	3	3	3	
1	0.8	0.8	0.8	0.8	0.8
1361 [53.6]	1331 [52.4]	1510 [59.4]	1547 [60.90]	1798 [70.8]	1914 [75.35]
636 [25]	670 [26.4]	723 [28.5]	848 [33.38]	693 [27.3]	794 [31.25]
792 [31.2]	835 [32.9]	1050 [41.3]	1075 [42.32]	1097 [43.2]	1173 [46.18]
571 [1259]	561 [1237]	852 [1879]	898 [1979]	1273 [2806]	1360 [2998]

QMS SERIES

60 Hz Generator Sets

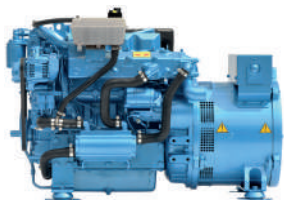

	Model	QMS 9M60	QMS 12M60
Configuration		3 cylinders in line	4 cylinders in line
Engine base		Kubota	Kubota
Fuel system		Mechanical	Mechanical
Injection system		Indirect	Indirect
Intake		Naturally aspirated	Naturally aspirated
Displacement	L [in ³]	1.1 [68.5]	1.5 [91.4]
Rated speed	rpm	1800	1800
Sound Shield option		✓	✓
GENERATOR RATINGS			
Frequency	Hz	60	60
Cont. power	kW [kVA]	8 [8]	10.7 [10.7]
Prime power	kW [kVA]	9.1 [9.1]	12 [12]
Voltage	V	120-240	120-240
Phase		1	1
Power factor		1	1
DIMENSIONS WITHOUT SOUND ENCLOSURE			
Length	mm [in]	840 [33.1]	925 [36.4]
Width	mm [in]	489 [19.2]	489 [19.2]
Height	mm [in]	620 [24.4]	620 [24.4]
Dry weight	kg [lbs]	224 [494]	244 [538]
DIMENSIONS WITH SOUND ENCLOSURE			
Length	mm [in]	950 [37.4]	1050 [41.3]
Width	mm [in]	540 [21.3]	540 [21.3]
Height	mm [in]	710 [28]	710 [28]
Dry weight	kg [lbs]	271 [598]	291 [641]



QMS 20M60	QMS 12T60	QMS 16T60	QMS 25T60
4 cylinders in line	3 cylinders in line	4 cylinders in line	4 cylinders in line
Kubota	Kubota	Kubota	Kubota
Mechanical	Mechanical	Mechanical	Mechanical
Indirect	Indirect	Indirect	Indirect
Naturally aspirated	Naturally aspirated	Naturally aspirated	Naturally aspirated
2.2 [134]	1.1 [68.5]	1.5 [91.4]	2.2 [134]
1800	1800	1800	1800
✓	✓	✓	✓
60	60	60	60
16.4 [16.4]	8.3 [10.4]	11.0 [13.8]	16.8 [21.0]
19.6 [19.6]	9.4 [11.8]	12.4 [15.5]	20.2 [25.3]
120-240	120-240	120-240	120-240
1	3	3	3
1	0.8	0.8	0.8
1014 [39.9]	840 [33.1]	925 [36.4]	1014 [39.9]
548 [21.6]	489 [19.2]	489 [19.2]	548 [21.6]
691 [27.2]	620 [24.4]	620 [24.4]	691 [27.2]
328 [723]	224 [494]	244 [538]	328 [723]
1130 [44.5]	950 [37.4]	1050 [41.3]	1130 [44.5]
600 [23.6]	540 [21.3]	540 [21.3]	600 [23.6]
700 [27.6]	710 [28]	710 [28]	700 [27.6]
378 [833]	271 [598]	291 [641]	378 [833]

QLS SERIES

60 Hz Generator Sets

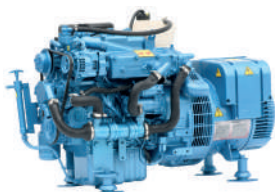

	Model	QLS 12T60	QLS 16T60
Configuration		3 cylinders in line	4 cylinders in line
Engine base		Kubota	Kubota
Fuel system		Mechanical	Mechanical
Injection system		Indirect	Indirect
Intake		Naturally Aspirated	Naturally Aspirated
Displacement	L [in ³]	1.1 [68.5]	1.5 [91.4]
Rated speed	rpm	1800	1800
Sound Shield option		✓	✓
GENERATOR RATINGS			
Frequency	Hz	60	60
Cont. power	kW [kVA]	8.7 [10.9]	11.7 [14.6]
Prime power	kW [kVA]	9.9 [12.4]	13.1 [16.4]
Voltage	V	120-240	120-240
Phase		1	3
Power factor		1	0.8
DIMENSIONS			
Length	mm [in]	959 [37.8]	1081 [42.5]
Width	mm [in]	489 [19.3]	486 [19.1]
Height	mm [in]	624 [24.6]	620 [24.4]
Dry weight	kg [lbs]	251 [553]	264 [582]

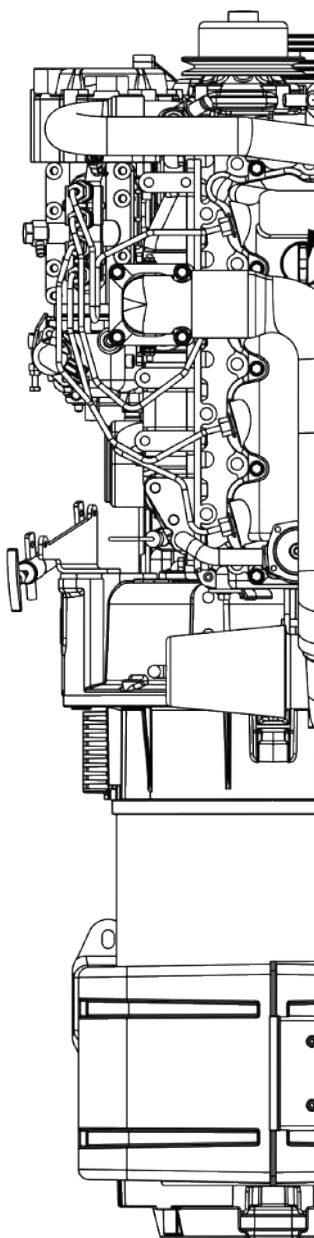
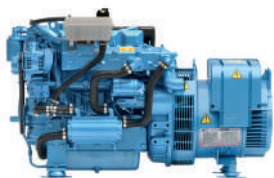

QLS 27T60	QLS 115T60
4 cylinders in line	6 cylinders in line
Kubota	John Deere
Mechanical	Mechanical
Indirect	Direct
Naturally Aspirated	Turbo
2.2 [134]	6.8 [414]
1800	1800
✓	
60	60
17.9 [22.4]	92.1 [115.1]
21.4 [26.8]	107 [133.8]
120-240	480
3	3
0.8	0.8
1167 [46.6]	2202.4 [86.7]
548 [21.6]	745.5 [29.35]
692 [27.2]	1205.9 [40.4]
360 [794]	1273 [2806.5]

NANNI HYBRID SYSTEM

For many years, Nanni's development focus has been the environmental performance of its propulsion systems. We aim to make engines progressively cleaner and more efficient.

The hybrid system is the proof of Nanni's commitment to reducing exhaust emissions. It offers a clean, smooth and amazingly quiet boating experience, where mechanical and electric power work in unison.

ECO-SENSITIVE & USER-FRIENDLY TECHNOLOGY

The hybrid system seamlessly integrates an electric motor and a diesel engine.

The electric motor is a compact yet formidable power source. In propulsion mode, it is used at low speeds, propelling the boat with no emissions, noise and vibrations. In generator mode, it produces electrical energy to recharge the batteries by converting the mechanical power supplied by the combustion engine.

The hybrid technology results in a highly reliable propulsion system, where the propeller can be driven either by the electric motor or by the combustion engine, which remains the main source for propulsion at high speed

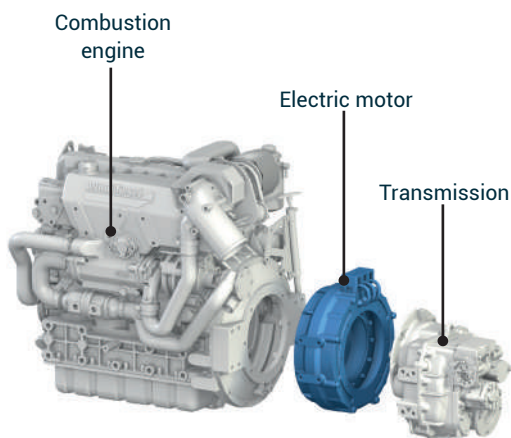

NOTES

NOTES



NANNI INDUSTRIES S.A.S.

11, Avenue Mariotte

33260 La Teste France

Tel: +33 (0)5 56 22 30 60

Fax: +33 (0)5 56 22 30 79

www.nannienergy.com