



# MARINE PRODUCT GUIDE

FEBRUARY 2021

# POWER PARTNERS



## A STRONG HISTORY OF RELIABLE SOLUTIONS

THE TWIN DISC FAMILY OF PRODUCTS



PROPULSION SYSTEMS



MARINE TRANSMISSIONS



SURFACE DRIVES



REAR ENGINE  
POWER TAKE-OFFS



MARINE CONTROL  
DRIVES



ELECTRONIC  
CONTROLS



PROPELLERS



TWINDISC.COM

## TABLE OF CONTENTS

Twin Disc Marine Product Information . . . . .	2-31
Service Classification Definitions . . . . .	34
Important Application Information . . . . .	35
Pleasure Craft . . . . .	36-41
Standard and QuickShift Marine Transmission Ratings	
Light Duty . . . . .	42-47
Standard and QuickShift Marine Transmission Ratings	
Intermediate Duty . . . . .	48-55
Standard and QuickShift Marine Transmission Ratings	
Medium Duty . . . . .	56-63
Standard and QuickShift Marine Transmission Ratings	
Continuous Duty . . . . .	64-71
Standard and QuickShift Marine Transmission Ratings	
Standard and QuickShift Marine Transmission Dimensions . . . . .	72-77
Veth Propulsion Definitions . . . . .	78-79
Veth Main Propulsion Ratings . . . . .	80-99
Veth Auxiliary Power Unit Ratings . . . . .	100-105
Twin Disc Global Service . . . . .	106-107
Twin Disc Locations . . . . .	108-109

### COVER: ELECTRIC POWER FOR GREENER DREDGER

*The Afonso De Albuquerque is a trailing suction hopper dredger built with a state-of-the-art filter system to meet the latest ultra-low emission vessel (ULEV) standards. The vessel features two electric-driven VZ-1250 rudder propellers (1100 kW) and one 2-K-1300 Veth Jet bow thruster. The dredger, one of more than two dozen Veth projects with the Jan De Nul Group, plays an important role in maintaining navigable waterways, enabling offshore energy production and reclaiming land.*

Copyright: Jan De Nul Group

# VETH RUDDER PROPELLERS

## MAXIMUM MANEUVERABILITY

The basic principle of a rudder propeller is simple and effective. The propeller rotates 360° around its own vertical axis to guarantee maximum maneuverability in all directions.

Our azimuth thrusters are available in either Z- or L-drive configurations and can be powered by any power source; the control for its azimuth steering system can be either electric or hydraulic. The thruster units are available with open propeller, contra-rotating propellers or with a nozzle. The Veth Control Systems are developed in-house by our R&D department. Veth Propulsion has developed the Veth Integrated L-drive with a permanent magnet (PM) motor, which has extremely low mounting space requirements.

By stocking the standard parts for every one of our thrusters, we can provide fast service when needed.

## Z-DRIVE

- 360° full thrust for optimal maneuverability
- 2% more efficiency than with a conventional propeller
- Possibility for flexible suspension (better insulation from noise and vibration)
- Ability to change propeller without docking
- Simple to install
- More room for passengers/cargo due to compact construction
- No separate gearbox needed
- Ideally suited for Dynamic Positioning (DP)
- Safer, through shorter emergency stopping distance and improved maneuverability



## INTEGRATED L-DRIVE

- Compact design; extremely low mounting space requirements
- High efficiency
- Quiet
- Low weight
- Built using proven Veth Propulsion technology
- Outstanding maneuverability due to the 360° thrust
- Electric motor inside the ship; fewer vulnerable components underwater
- Simple to install
- Slip ring cabinet unnecessary
- Optimal flow of water thanks to 'Shark Tail' on contra-rotating propeller

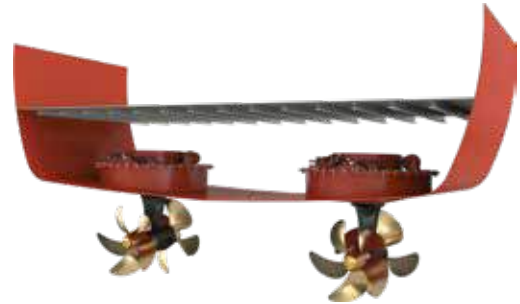
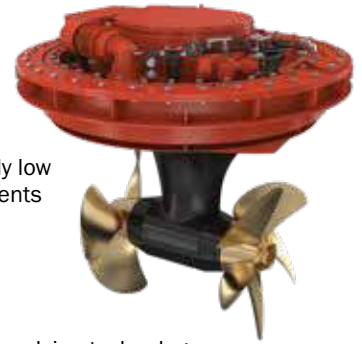

**VETH**  
PROPULSION  
BY TWIN(DISC)

# VETH RUDDER PROPELLERS

## MAXIMUM MANEUVERABILITY

The basic principle of a rudder propeller is simple and effective. The propeller rotates 360° around its own vertical axis to guarantee maximum maneuverability in all directions.

Our azimuth thrusters are available in either Z- or L-drive configurations and can be powered by any power source; the control for its azimuth steering system can be either electric or hydraulic. The thruster units are available with open propeller, contra-rotating propellers or with a nozzle. The Veth Control Systems are developed in-house by our R&D department. Veth Propulsion has developed the Veth Integrated L-drive with a permanent magnet (PM) motor, which has extremely low mounting space requirements.

By stocking the standard parts for every one of our thrusters, we can provide fast service when needed.

## Z-DRIVE

- 360° full thrust for optimal maneuverability
- 2% more efficiency than with a conventional propeller
- Possibility for flexible suspension (better insulation from noise and vibration)
- Ability to change propeller without docking
- Simple to install
- More room for passengers/cargo due to compact construction
- No separate gearbox needed
- Ideally suited for Dynamic Positioning (DP)
- Safer, through shorter emergency stopping distance and improved maneuverability



## INTEGRATED L-DRIVE

- Compact design; extremely low mounting space requirements
- High efficiency
- Quiet
- Low weight
- Built using proven Veth Propulsion technology
- Outstanding maneuverability due to the 360° thrust
- Electric motor inside the ship; fewer vulnerable components underwater
- Simple to install
- Slip ring cabinet unnecessary
- Optimal flow of water thanks to 'Shark Tail' on contra-rotating propeller

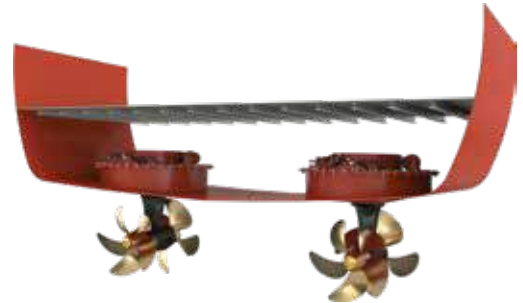
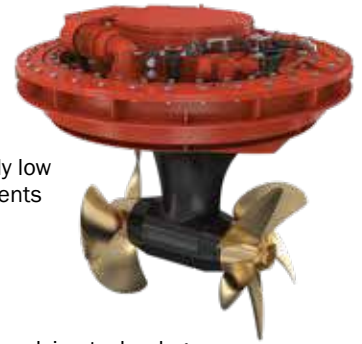

**VETH**  
PROPULSION  
BY TWIN(DISC)

# VETH CONTROL SYSTEMS

## PROVEN TECHNOLOGY

Like all of our products, our control systems are also developed and produced in-house. The Veth Control Systems (VCS) offer you the opportunity to read out, monitor and analyze data and alarms. The choices Veth Propulsion makes are based on dynamic and proven technologies from the automotive industry.



CONTROL PANEL



KEY PANEL



FRONT DISPLAY THRUSTER

## DRIVEN BY SIMPLICITY

Veth Propulsion has its own R&D department for electronics, which is engaged with in-house development, innovation and improvement of our control systems on a daily basis. This is in line with the everything-under-one-roof principle and offers several advantages. Simplicity for you as a key user and for service purposes is most important in the continuous development of our control systems.

## FEATURES & BENEFITS

- Fast service
- Single contact point
- Sufficient stock
- In-house knowledge and skills
- Not dependent on others
- Interfacing with third-party systems is developed and maintained internally, such as DP, Pilot and VDR interfaces
- The Veth Autopilot interface provides the ability to control the thruster asynchronously
- The DP interface provides safety around the DP control



LOCAL PANEL



WING PANEL

# MARINE CONTROL DRIVES

## FIELD PROVEN, MODERN DESIGN

Capitalizing on more than 30 years of rugged applications, the new Twin Disc Marine Control Drives (MCD) Series offer distinct operating advantages for any vessel requiring highly accurate positioning or extreme slow-speed maneuverability while splitting main engine power to operate high-powered FiFi pumps or other auxiliary gear. Power capacities now range from 1680 to 5250 kW (2250 to 7040 HP).

## FEATURES & BENEFITS

- Provides operating advantages for vessels requiring highly-accurate positioning
- Used in conjunction with Azimuth Thruster systems
- Best alternative to controllable pitch propellers (CPP)
- Dynamic positioning (DP) capable
- High-capacity PTO to drive auxiliary equipment
- Emergency “come home” device per classification requirements
- Smooth, gradual propeller speed change resulting in improved maneuverability
- Safer and easier vessel control during slow speed maneuvering and docking
- Adjustment of propeller speeds below engine speed rating
- Divides the power from the main propulsion engine to eliminate the need for auxiliary engines
- Delivers an instant response when required
- Bearing calculated for high universal joint angles at maximum power
- Compared to controllable pitch propeller (CPP), the Marine Control Drives can be serviced inboard without the need to dry-dock or diver support
- Slipping from engine idle to wide open throttle; Twin Disc expert application team will help customize to any desired operator requirement

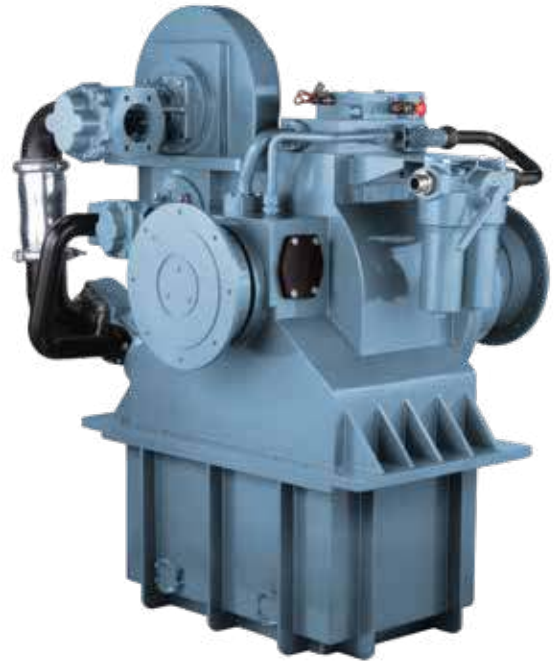

LD MODELS	
Model	kW/rpm
2000-1-LD	1.20
2000-2-LD	1.60
2000-3-LD	2.00
4000-1-LD	2.40
4000-2-LD	2.80
4000-3-LD	3.20
4000-4-LD	3.60
4000-5-LD	3.75

HD MODELS		
Model	kW/rpm	Dissipation
2000-1-HD	1.20	100 kW
2000-2-HD	1.60	130 kW
2000-3-HD	2.00	160 kW
4000-1-HD	2.40	190 kW
4000-2-HD	2.80	225 kW
4000-3-HD	3.20	250 kW
4000-4-HD	3.60	290 kW
4000-5-HD	3.75	330 kW
5000-1-HD	3.75	400 kW
5000-2-HD	3.75	450 kW

## VETH BOW THRUSTERS

Many Veth bow thrusters are part of the shallow draft family. A major advantage of a horizontal propeller (shallow draft) is that optimum thrust is achieved at minimum draft, without vulnerable parts sticking out beneath the vessel. The shallow draft thrusters provide high thrust even at cruising speed, because the propeller draws up the water over a short length.

### VETH JET

The Veth Jet channel bow thruster, an invention of Jan Veth, was launched in 1970 in response to market demand for a thruster that could function optimally at 360° with a shallow draft.



### VETH COMPACT JET

The Veth Compact Jet can be found only at Veth Propulsion. A special feature of the Veth Compact Jet is that the propeller is placed at an angle of 17°. In practice, this means more efficiency and higher thrust on a sailing vessel.



### VETH STEERING GRID

With a Veth Steering Grid, you achieve optimal thrust at minimum draft, even at speed and with no parts extending from beneath the vessel. The Veth Steering Grid makes use of existing technology found in the successful Veth Jet, such as the worm wheel and gear transmission.



### VETH COMPACT GRID

The Veth Compact Grid offers the advantages of two existing Veth solutions: the simplicity of the Veth Steering Grid and the angled propeller of the Veth Compact Jet.



Each vessel is unique and it may be that a regular tunnel thruster does not meet your needs. Veth Propulsion also offers aluminum, flexible mounted (combined with air injection), elbow or retractable tunnel thrusters.



## TWIN DISC HYDRAULIC THRUSTERS

### RELIABLE AND HIGH PERFORMING

Our years of experience in propulsion technologies have brought Twin Disc to the development of our thrusters line. Compact design and easy installation make Twin Disc hydraulic thrusters a favorite among major boatyards.

### FEATURES & BENEFITS

- Combines the need for higher thrust requirements and longer working cycles with the builders' need to control the total weight and dimensions, and the final system cost
- Bow- and stern-mounting options
- Complete range for applications up to 130'
- Double counter-rotating propeller
- Transmission gears built in high-tensile materials
- High-quality materials suitable to the marine environment
- Wide range of hydraulic components in different sizes for a complete system and different configurations
- Compact leg design for a low hydrodynamic resistance
- Reduced noise
- 'Brand name' hydraulic components for easy access to spare parts
- Easy installation
- Conforming to the highest production standards



### HYDRAULIC THRUSTER TECHNICAL DATA

Model	Nominal Thrust Kgf • N (lbs)	Tunnel I.D. mm (in)	Nominal Power kW (hp)	Weight kg (lbs)
BP 220	220 • 2158 (485)	250 (9.83)	18.7 (25)	24 (53)
BP 300	300 • 2943 (661)	300 (11.80)	28.5 (38)	35 (77)
BP 400	400 • 3924 (881)	355 (14)	35 (47)	45 (99)
BP 550	550 • 5886 (1322)	400 (15.75)	48.5 (65)	75 (165)
BP 600	600 • 5886 (1333)	450 (17.72)	60 (82)	85 (189)

These values are intended to be indicative. The performance of each thruster depends on several different factors and on the sizing of the hydraulic components. Contact the Twin Disc Applications Engineering Department for suggestions on the most suitable configuration at [applications@twindisc.com](mailto:applications@twindisc.com).

## QUICKSHIFT® MARINE TRANSMISSIONS



**QUICKSHIFT®**  
BY TWIN(DISC)

### FAST, SMOOTH SHIFTS

No other marine transmission in the world shifts as fast and smooth as the Twin Disc QuickShift, yet it provides amazing control at near zero vessel speed.

### FEATURES & BENEFITS

- Patented, completely internal and integrated clutch actuating system
- Regulates engine torque at extremely low speeds to slow the propeller speed down to 50 rpm or less — allowing you to maneuver at near zero boat speed, an incredible advantage in docking
- Instantly delivers cushioned torque to the driveline when shifting from neutral to anywhere from full ahead to full reverse
- Eliminates driveline shock while optimizing power to the driveshaft
- Steep but smooth power curve (full out or at slow speeds)
- Superior maneuvering control
- Instant power to propeller

## TWIN DISC POWER COMMANDER™

### ULTIMATE CONTROL IN YOUR HANDS

Leading the industry in quality, style and performance, the Twin Disc EC300 Power Commander electronic control system is designed to interface with all popular electronic engines and transmissions. It is versatile, rugged and easy to install. With literally one finger on one lever, the operator can control the boat's speed and direction. Multiple drivetrains and multiple control heads can easily be accommodated. Multiple electronic control stations can be placed around the boat.

 **POWER COMMANDER™**

BY TWIN(DISC)



### FEATURES & BENEFITS

- Single lever control
- Selectable synchronization
- Trolling valve control option
- J1939, RS232, RS485 coms
- Allows up to eight control stations
- Cast aluminum control boxes with stainless steel levers (two length options)
- Express Joystick System® ready
- Selectable station transfer rules
- Individual station active indicators
- Individual station neutral indicators
- 12 and 24 volt system power compatible
- Full functionality of QuickShift gears
- Independent port/STBD J1939 CAN-bus communication links
- Hall Effect lever position sensors provide enhanced reliability and longest shifting life possible



## EXPRESS JOYSTICK SYSTEM® (EJS®)

### DON'T BUY YOUR NEXT BOAT WITHOUT IT

The Twin Disc Express Joystick System (EJS) absolutely revolutionizes docking and slow speed maneuvering of diesel powered, conventional shaftline boats.

With easy fingertip movements you control direction and speed – instantaneously and intuitively. No lugging. No lurching. No clunking. All thanks to proven QuickShift transmission and EC300 control technology.



### FEATURES & BENEFITS

- “Push, twist and go” directional maneuvering
- Proven QuickShift transmission and EC300 control technologies
- Simultaneously and instantaneously controls engines, transmissions and thrusters
- During docking, eliminates steering wheel and control lever activities
- Effortlessly move the boat in any direction and even pivot on its own axis
- Extremely intuitive responsiveness
- Ergonomically friendly
- Remarkably easy to learn
- Interfaces are available for non-Twin Disc thrusters, please contact Twin Disc for availability

## EXPRESS POSITIONING®

### MAINTAIN POSITION WITH THE TOUCH OF A BUTTON

Based on the award-winning EJS, Express Positioning maintains a vessel in a fixed position and heading at the touch of a button. A dedicated, highly accurate and reliable GPS receiver determines the vessel's exact location and heading and the Twin Disc EC300JS controller commands the Twin Disc QuickShift transmissions and Twin Disc proportional hydraulic thrusters to smoothly and instantaneously maintain the precise station coordinates and heading.\* Never before have shaft line boats been able to so effortlessly hold position.



### FEATURES & BENEFITS

- Works only in conjunction with Twin Disc Express Joystick System
- Maximum power available to continuously hold station without producing excess heat or wear
- Compatible with single- and twin-engine applications
- Compatible with twin-engine bow or bow/stern thruster applications
- Can be retrofit to existing EJS applications
- Based on years of experience with Dynamic Positioning systems in commercial vessels
- Only QuickShift transmissions provide the smooth, responsive shifting and propulsion control required
- QuickShift transmissions and precision hydraulic thrusters provide ultra fine maneuvering control at low thrust levels

\* Vessel position may not be maintained in all sea and weather conditions. Captain is responsible for the safe operation of the vessel.

## Sample Diagram

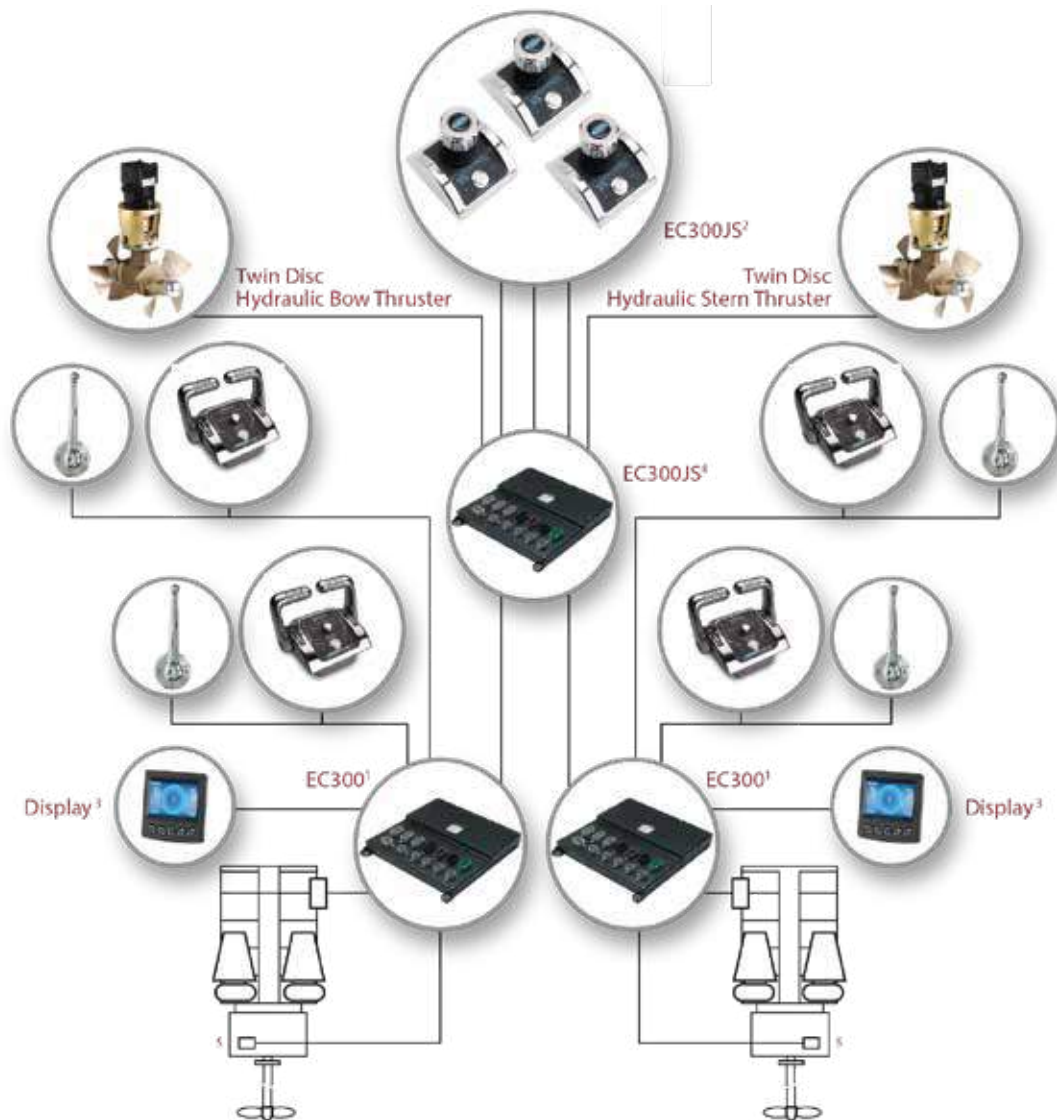

1 EC300: Standard control system for up to seven digital stations and up to eight engine/transmission shaft lines per vessel.

2 EC300JS: Express Joystick System option for up to six joystick stations.

3 Color display option (shown).

4 Available GPS option, station-keeping, Express Positioning System.

5 Twin Disc QuickShift transmissions required.

PLEASE CONTACT TWIN DISC OR A TWIN DISC AUTHORIZED DISTRIBUTOR FOR MORE DETAILS.

# EC300DP ELECTRONIC CONTROL SYSTEM

## TOTAL PROPULSION CONTROL

The Twin Disc EC300DP propulsion control package allows instantaneous, shockless and virtually constant forward and reverse shifting to keep supply vessels on station as directed by the craft's dynamic positioning system. Twin Disc Power Commander Electronic Controls give you total control with electronic precision and, literally, fingertip ease. With only one lever required per engine, you can control your boat's speed and direction with one hand. You get responsive control over the entire speed range.

## FEATURES & BENEFITS

- High thrust rate change competitive with alternative drive packages
- More than 30x/minute directional reversals
- Designed for conventional shaft lines with QuickShift transmissions
- Linear thrust control from 10% of idle engagement to full engine power
- Maintain fuel-efficient engine speeds even at low propeller speeds
- Meets DP2 requirements
- Enhanced installation, monitoring and maintenance/ service software
- Versatile, rugged and easy to install
- Designed to interface with all popular electronic engines and DP systems



## DP INTERFACE SYSTEM (EC300DP) – Sample Diagram

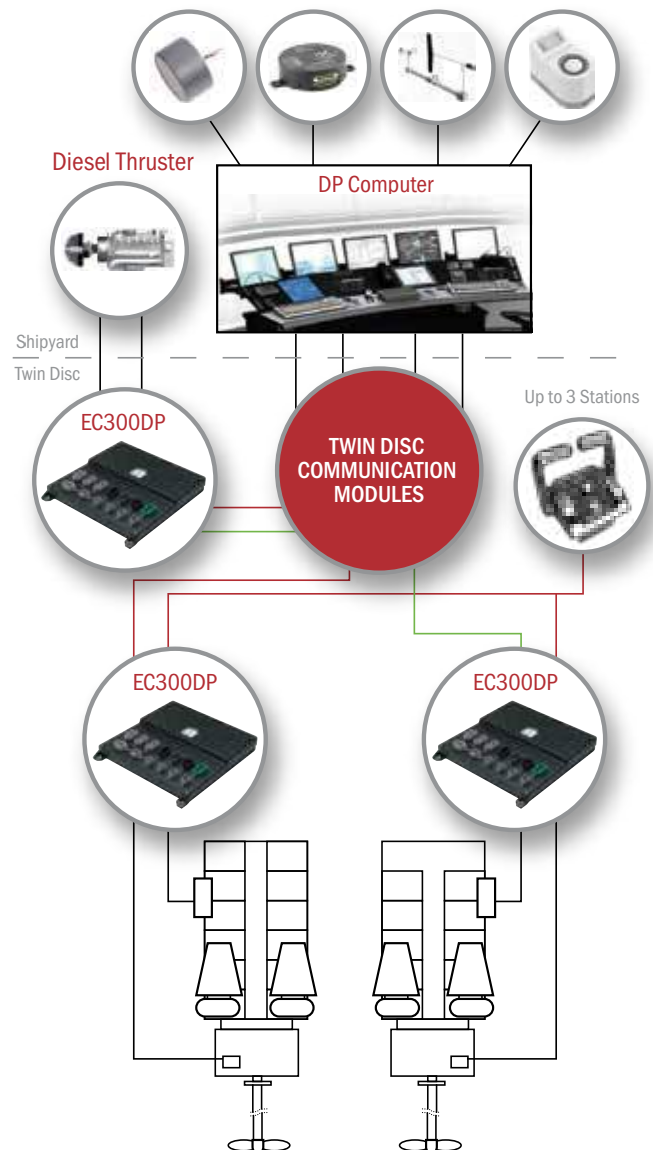

1. The Twin Disc EC300DP control system is suitable for DP0, DP1 and DP2 vessels with conventional propellers and two (2) or more engine/transmission drivelines.
2. Twin Disc QuickShift transmissions required.

PLEASE CONTACT TWIN DISC OR A TWIN DISC AUTHORIZED DISTRIBUTOR FOR MORE DETAILS.



# BACKUP PROPULSION CONTROL SYSTEM

## Twin Disc-Supplied Operator Panel

For use with EC300 Power Commander and Twin Disc marine transmissions.

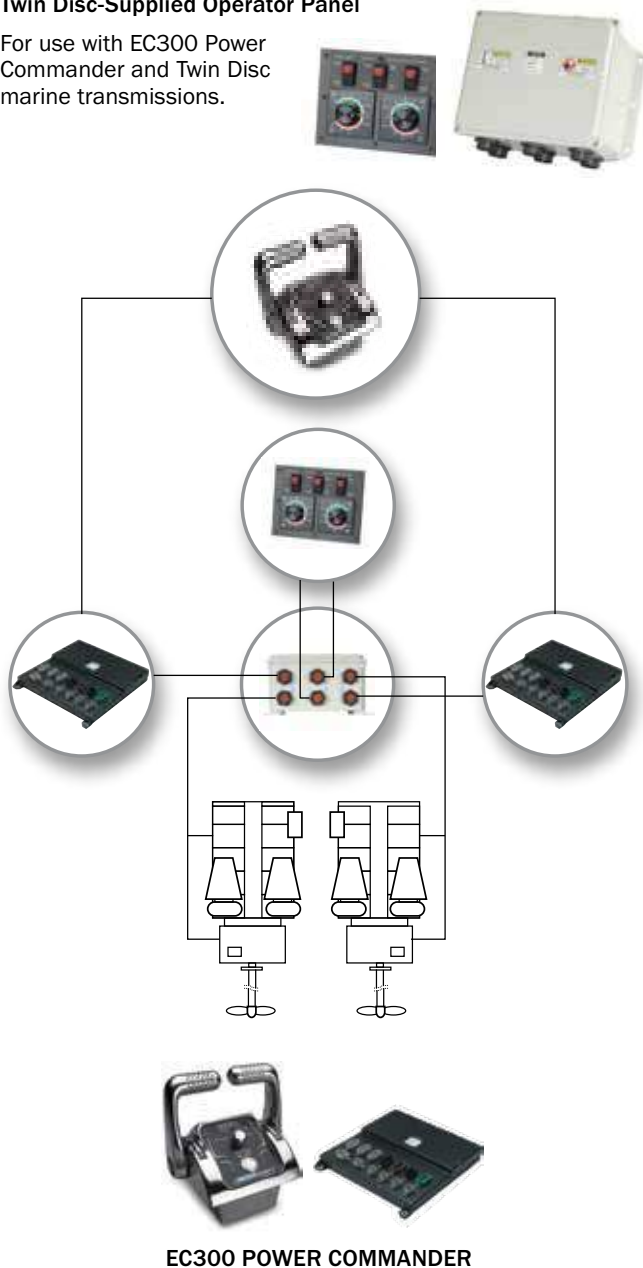

EC300 POWER COMMANDER



## Customer-Supplied Local Operator Panel

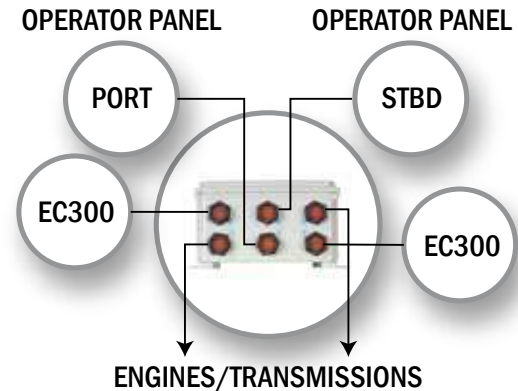

## FEATURES & BENEFITS

- Provides fully redundant and independent propulsion control of EC300 Power Commander systems with electronically-governed engine and Twin Disc QuickShift and standard marine transmissions
- Includes a twin engine interface box, operator panel and associated harnesses
- Interface box developed to be plug and play with Twin Disc QuickShift and standard marine transmissions configured for EC300
- Intuitive operator panel with integrated throttle/transmission control knobs
- 4-20mA standard throttle signal (contact factory for other options)
- Backup engine and marine transmission commands can be received directly from a compatible, customer-supplied local operator panel in place of the Twin Disc operator panel
- Interface box has integral “direction confirmation” feedback for engine systems which require potential free contacts to confirm ahead, neutral, astern
- Integrated neutral start interlock to inhibit engine start when either the backup system is commanding clutch engagement, or the marine transmission manual override is engaged
- Two interface boxes and operator panels can be used for backup on triple or quad-screw vessels
- Option for backup control of Twin Disc marine transmission with internal shaft brake

## E-STEER™ POWER STEERING SYSTEM

Introducing E-STEER (ES4000), Twin Disc's latest generation power steering system, based on CAN bus communication architecture and 24VDC and 380V AC hydraulic power packs. The ES4000 compliments our existing line of hydraulic steering systems, power assisted hydraulic systems, and electronic over AC powered hydraulic power packs.

### FEATURES & BENEFITS

- Dual Bus Technology: Every system has redundant CAN bus communication cables. If one bus is taken down, the system still operates off the other bus.
- Optional Dual Control Systems: While a single control system can operate two rudder systems, addition of a second control module provides further redundancy to operate secondary hydraulic rudder systems in the event of a failure of the primary system
- Dual Power: Each control has a primary and secondary power input, with audible alarms for loss of either supply
- Manual Control Option: A hydraulic helm unit can be installed for further backup of the electronic system
- Speed Sensing™ adaptive steering with dynamic rudder control
- Color display with intuitive graphics of rudder position, system operating status, and fault conditions
- Auto-pilot interface
- Joystick tiller option
- Active helm unit has option for auto-return to center
- Station transfer for multiple helms
- Electronic tie-bar feature
- Programmable for tuning steering system for optimal vessel performance

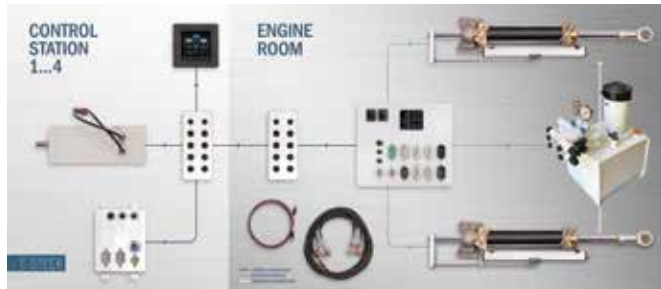

## TWIN DISC STEERING SYSTEMS

### HYDRAULIC AND ELECTRONIC OPTIONS

Our steering systems are a combination of selected materials, innovative design and state-of-art technical solutions. All components are built with high precision systems and tooling to meet the requirements of the best survey authorities such as RINA, Lloyd's Register, ABS and Bureau Veritas.

### FEATURES & BENEFITS

- Wide variety of possible configurations
- Suitable for either small/medium pleasure boats and commercial vessels
- Highly-flexible and efficient electronic systems are suitable for applications up to 230'
- Electronic systems support over 100 application types
- Decades of experience in the production of electronic power-assisted steering
- Ensure performance and durability
- Hydraulic cylinders and helm pumps can handle many different applications.

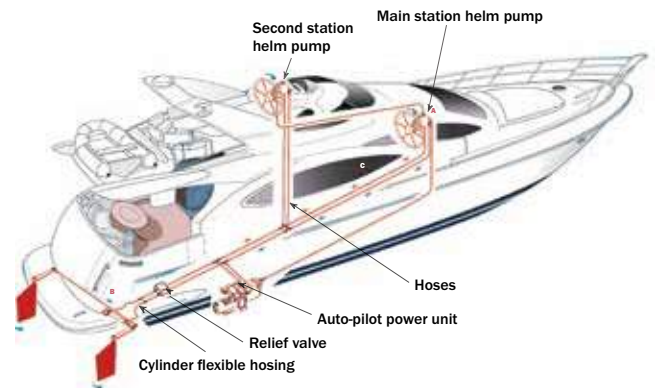



### RELIABLE EXTRA CAPACITY

The MGXT-5202SC has built upon the proven reliability of the MGX-5202SC marine transmission, combined with an industrial pump tower. The pump tower can be mounted in multiple orientations to suit the installation requirements for applications where multiple pads for hydraulic pumps are needed. This model is well suited for applications where additional pump pad capacity is required, such as dredges.

### FEATURES & BENEFITS

- Two towers with two pump pads each
- 224 kW (300 HP) maximum capacity per tower
- 358 kW (480 HP) maximum capacity for both towers
- SAE #0 & SAE #1 input housing
- Pump tower rotatable by 0°/45°/90° CW
- Available pump pads:  
SAE "A" • SAE "B" • SAE "C" • SAE "D"
- Standard marine transmission ratings apply

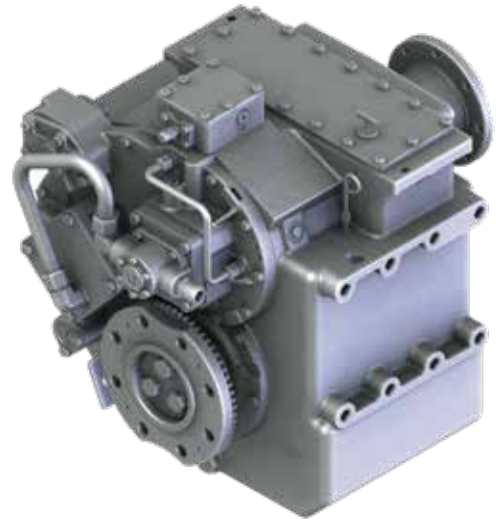

### RESPONSIVE POWER

Twin Disc has taken its field-proven marine transmissions and created the MGE Series of gearboxes. This design provides power from the motor immediately in both clockwise and counter-clockwise directions. All units are equipped with a bi-directional oil pump to provide lubrication no matter the direction of shaft rotation, making these units a perfect fit for serial hybrid and diesel-electric applications or any application requiring a direct power response with a ratio reduction.

### FEATURES & BENEFITS

- Bi-directional lubrication pump
- Simplified design without a clutch
- Same installation envelope as standard marine transmission
- Standard marine transmission ratings apply
- SAE #0, SAE #1 input housing & freestanding applications
- SAE 460 (18") & SAE 355 (14") input coupling
- Type Approvals and Certifications available upon request
- Available models: MGE-5204SC and MGE-5126SC;  
other models by request

# ARNESON® SURFACE DRIVES

## SPEED IS JUST THE BEGINNING

Mechanical innovator and offshore racing enthusiast Howard Arneson perfected the performance and reliability of surface-piercing propulsion. Twin Disc then made Arneson Surface Drives available for non-racing applications – pleasure craft and commercial vessels, as well as military applications. Arneson Surface Drives are renowned as the most reliable and proven surface-piercing propulsion system with decades of successful applications in pleasure, commercial and military vessels.

## FEATURES & BENEFITS

- Cleaner hull, trimable drive shaft and adjustable angle
- Completely eliminates cavitation, thus increasing propeller performance while reducing cavitation erosion
- Manufactured for maximum duty applications and to last the life of the vessel using high-quality, corrosion-resistant materials matched to exacting tolerances
- Models designed to fit virtually every powerplant option, accommodating torque outputs exceeding 16,500 lb-ft
- Can be combined with Twin Disc QuickShift transmissions and EC300 control systems

MODEL		ASD08	ASD10
HORSEPOWER ACCEPTANCE	GASOLINE @ 5200 rpm	To 990	To 1485
	DIESEL @ 2400 rpm	To 380	To 565
	GAS TURBINE	Contact Twin Disc, Inc.	
ASD INPUT SHAFT TORQUE LIMITS <sup>1</sup> (lbs-ft)		1200	2000
NOMINAL SHAFT SIZE (inches)		2.00	2.50
UNIT WEIGHT (pounds, dry, includes ASD unit, trim and steering cylinders, trim pump, reservoir, mounting hardware and hoses) <sup>2</sup>		B 285	B 415
OVERALL EXTERNAL LENGTH (inches)		42	53
THRUST SOCKET DIAMETER (inches)		8	10
THRUST SOCKET FLANGE DIAMETER (inches)		12	14
TURNING ANGLE (total)		40°	40°
PROPELLER TRIM CONTROL (vertical travel)		15°	15°

1. Torque ratings shown are nominal and may vary due to vessel characteristics.



**ARNESON®**  
BY TWIN(DISC)

- Accelerate faster and achieve higher top end than conventional drives
- Reduce underwater drag by 50% compared to conventional submerged propeller drive systems and provide more efficient thrust
- Can reduce engine costs while maintaining performance
- Better payload-to-power ratio
- Outperforms waterjets in high-speed applications
- Enhanced contactless position sensor for trim and steering cylinders, gauge included

ASD11S	ASD12	ASD14	ASD15S	ASD15L	ASD16
–					
To 850	To 1400	To 1800	To 2100	To 2400	Contact Twin Disc, Inc.
Contact Twin Disc, Inc.					
3200	4800	8000	11500	13500	16500
2.875	3.30	3.50	4.50	4.50	4.50
B 515	B 785	B 1135	A 1500	A 1540	A 1985
57	63	71	78	78	87
10	13	15	19	19	20
14	17	19	21.25	21.25	23
40°	40°	40°	36°	36°	36°
15°	15°	15°	15°	15°	15°

2. A: Aluminum housings  
B: Bronze housings

## A NEW LEVEL OF PERFORMANCE AND CONTROL

Based on the robust Twin Disc EC300 electronic control platform, Mastertrim is a programmable trimming system which adjusts the trim of the Arneson Surface Drive and the vessel's trim tabs or interceptors to preset positions based on vessel speed and operator-selected modes.

## FEATURES & BENEFITS

- Four operating modes selected to suit conditions
- Select manual mode by simply pressing the mode switch, or by manually trimming any one of the drives or tabs
- On-board diagnostics constantly monitor the health of the electronic controls system and displays instant feedback
- No special electronics needed for system troubleshooting
- Frees the operator to focus on driving the boat, rather than adjusting the propulsion system
- Easily programmed during vessel commissioning via the supplied display; the system will guide the operator through static and dynamic calibrations

### Current installations supported:

- Twin drive with trim tabs or interceptors
- Tabs or interceptors are required
- Single helm station only

### System make up:

- Electronic controls
  - EC300MT control
  - MT display
  - Valve driver module
  - Interface to ship's GPS
  - Driveline speed sensors
  - Trim and steering position sensors
  - Interface to customer-provided trim and mode switches
  - Optional analog gauge kit
- Hydraulic system:
  - Twin Disc-supplied integrated trim and steering manifold must be used

**MASTERTRIM™**  
BY TWIN(DISC)

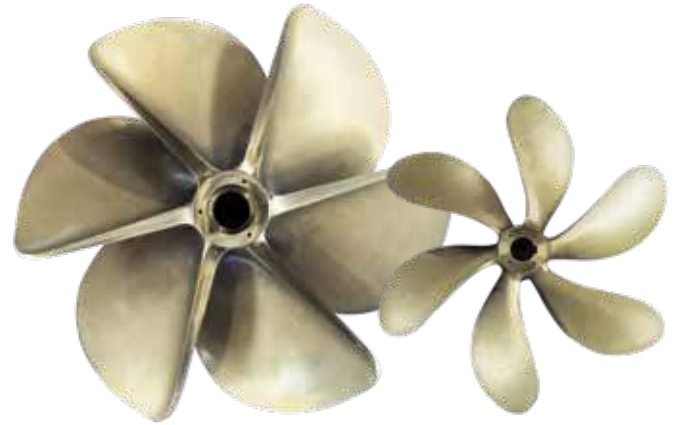

**ROLLA™**  
BY TWIN(DISC)

## ULTIMATE PROPELLER PERFORMANCE

Since 1963 the name Rolla has been synonymous with the highest quality, most efficient propellers in the world. What started with Philip Rolla individually designing and crafting race-winning propellers has grown to become the leader in propeller technology for high-performance pleasure and commercial craft and military vessels.

## FEATURES & BENEFITS

- Rolla stainless steel and NiBrAl propellers range from 16 inches to 10 feet in diameter
- Specifically custom designed for high-performance shaftline or surface drive applications
- Wide variety of service for every aspect of propeller design, manufacture and application
- Offers complete hydrodynamic analysis and engineering capabilities to computational fluid dynamic (CFD) hull analysis to sea trials



## TWIN DISC CUSTOM BUILT SHAFTLINES

### THE ESSENTIAL LINK

For over 60 years the Italian yachting industry has used our custom built water-lubricated shaft lines. As part of its integrated solution, Twin Disc offers the essential link between marine transmissions and submerged propellers, regardless if your vessel is a commercial craft, a luxury superyacht or a military vessel.

Each system is built to match the specific parameters of your vessel and can be approved by major classification societies such as Rina, BV, LRS and ABS.

### SYSTEMS INCLUDE:

- Propeller shaft (multiple stainless steel grades available)
- Stern tube in various materials with bearings and seals in several types and sealing brands
- Shaft bracket(s) – various shapes and materials available
- Propeller nut and cathodic protection
- Half coupling, if required, available in many technologies
- Flange and required bolts

When fitted with our marine transmissions, electronic controls and propellers, you get the guarantee of a single-source propulsion specialist.



## TWIN DISC CUSTOM BUILT RUDDERS

### CUSTOMIZED MANEUVERABILITY

As we do with shaftlines, Twin Disc designs, builds and supplies custom built rudders as part of its steering system.

We adapt to your needs and constraints without compromising on the maneuverability and reliability of your vessel. Steering is essential whether you run a passenger vessel, a patrol craft or a large luxury pleasure craft.

Our cast or welded rudders are made of marine bronze or high-grade stainless steel. Our team of welders is certified by major classification societies and our design follows the strictest rules of these same certification bodies.

### SYSTEMS INCLUDE:

- Rudder assemblies – multiple types, shapes and materials available
- Rudder tube assemblies in various materials with bearings and seals
- Tiller arm
- Tie bar, if required
- Flange and required bolts

When fitted with our electronic or hydraulic steering systems, you get the guarantee of a single-source steering specialist.

*If your vessel is 15m – 60m, please contact us.*



## SEAPROP 60 SAILDRIVE

### SAILING EASE AND VERSATILITY

The SeaProp 60 saildrive is a propulsion system for sailboats with engines rated up to 56 kW (75 hp) @ 3600 rpm. Sailboat manufacturers and operators alike benefit from this system's unique but proven design.

### FEATURES & BENEFITS

- Easy, space-saving installation
- Eliminates propeller shaft along with stuffing box, cutless bearing, stern tube and strut
- Can be matched with a variety of fixed or foldable propellers
- Sailboat manufacturer will overcome inherent limitations and problems of conventional inboard shaft drive installations with a quicker, more versatile and simplified engine installation process
- Easily mounted facing forward or aft
- Not constrained by shaft angle and offers the builder more versatility in engine placement and a smaller 'footprint' (no shaft, stuffing box, or strut aft of the engine)
- Increased propulsion efficiency as the thrust is parallel to the boat's waterline
- More efficient, quieter, creating less vibration to the boat and providing an all-around smoother experience
- No water leakage into the bilge through the stuffing box



### SAILDRIVE SP60 TECHNICAL DATA

RATIO		INPUT RATINGS - PLEASURE kW (HP)		
Forward	Reverse	2800 rpm	3000 rpm	3600 rpm
2.15	2.15	43 (59)	46 (63)	55 (75)
2.38	2.38	34 (46)	36 (50)	44 (60)

Max Input Speed: 3800 rpm

Dry Weight: 43 kg (94 lbs)

Oil Quantity: 2.8 liters (0.7 gallons)

## TWIN DISC TRIM TABS

### PERFORMANCE, SAFETY AND EFFICIENCY

Twin Disc offers trim tab systems in stainless steel and aluminum. Both are available in a large variety of dimensions and can be combined with four different hydraulic kits, satisfying many different requirements and covering a wide application field. A large selection of accessories are available to complete both stainless and aluminum systems and aid in easy and efficient use.

### FEATURES & BENEFITS

- Stainless steel offers highest corrosion resistance
- All Series MY3000, MY4000 and MY5000 are available in the simple tab (single plate) type for smaller boats or with lower loads, and the reinforced tab (reinforced plate) for larger applications
- MY3000 Series tabs are provided with a welded connection cylinder

#### Performance improvement

- Stern lifting and better balance
- Faster planing
- Better propeller efficiency for more in-line power
- Listing correction
- Decrease of yawing and wandering with cruising quality improvement

#### Safety improvement

- Better and greater visibility
- Better maneuverability at low cruising speed

#### Efficiency improvement

- Better engine performance
- Reduced fuel consumption
- Staying on plane even at slower cruising speed

## SERVICE CLASSIFICATION DEFINITIONS

### PLEASURE CRAFT

Up to 500 hours/year, low load factor usage planing hull vessels where typical full engine throttle operation is less than 10% of total time. The balance of operation at 80% of full engine throttle or less. Marine transmissions for use in long range pleasure cruisers, sportfish charter boats/patrol boats do not qualify for Pleasure Craft Service.

Note: Some revenue-producing applications such as Planing Hull Bristol Bay Gillnetter do qualify under Pleasure Craft rating definition.

### LIGHT DUTY

Relatively low hour usage (less than 1500 hours/year) where full throttle operation is 2 hours out of 12. Typical applications include planing hull vessels such as fire boats, sport-fish charter boats and patrol/customs boats. This rating is also applicable to some bow and stern thruster applications.

### INTERMEDIATE DUTY

Hour usage of up to 2000 hours/year (for models MG(X)-5114 and smaller) and up to 3000 hours/year (for models larger than MG-5114) with 50% of the operating time at full engine rating.

Typical applications include planing hull vessels such as ferries, fishing boats, some crew boats, and also some displacement hull yachts as well as some bow and stern thruster applications.

### MEDIUM DUTY

Hour usage of up to 4000 hours/year with up to 80% of operating time at full engine power. This duty classification is for usage where some variations in engine speed/power occur as part of normal vessel operation.

Typical vessels include mid-water trawlers, crew/supply boats, ferries and some inland water tow boats.

### CONTINUOUS DUTY

For use in continuous operation with little or no variation in engine speed/power settings.

Typical vessels include fishing trawlers, tow/tug boats and ocean going vessels.

### SPECIAL APPLICATIONS

Some applications such as Dynamic Positioning (DP), Wind Farm Service, and others, require Twin Disc Factory Approval.

## IMPORTANT APPLICATION INFORMATION

- Transmission ratings are based on use of the transmission in a torsionally compatible system utilizing a suitable input torsional coupling.
- Ratings are for diesel engines at the indicated speeds, unless otherwise indicated.
- Ratings are shown in SAE horsepower (HP).
- Consult factory for ratings applicable to gasoline engines, gas turbines, or other applications not conforming to the given service class definitions.
- Ratings apply to right hand engines (i.e., counter-clockwise flywheel rotation when viewing rear of engine).
- Transmission ratings should equal or exceed the engine's published ratings for the given application.
- Final marine transmission selections are to be confirmed prior to issuance of the purchase order. For unusual or unique applications, please contact Twin Disc, Inc. for product selection assistance.
- Marine transmission input couplings provided by Twin Disc are configured to interface with engine flywheels which conform to SAE J620 standards. Please consult Twin Disc when use of non-standard flywheels are considered.
- Most of the transmissions listed herein are to be mounted directly on the SAE flywheel housing of the engine. It is necessary that the engine crankshaft endplay be measured before the driven equipment is installed and rechecked after the driven equipment is installed. The endplay measurements, before and after transmission installation, should be the same. If not the same, the driven equipment should be removed and the problem source located and corrected before the engine is started. Engine crankshaft endplay measurement is considered mandatory.
- The given data is subject to modifications/corrections without prior notice.
- Use certified print for installation.

## IMPORTANT NOTICE

Disregarding propulsion system torsional compatibility could cause damage to components in the drive train resulting in loss of mobility. At minimum, system incompatibility could result in gear clatter at low speeds.

The responsibility for ensuring that the torsional compatibility of the propulsion system is satisfactory rests with the assembler of the drive and driven equipment.

Torsional vibration analysis can be made by the engine builder, marine survey societies, independent consultants and others. Twin Disc is prepared to assist in finding solutions to potential torsional problems that relate to the equipment of Twin Disc Incorporated's supply.

Model	Ratios	Kilowatts (Horsepower)			Maximum Speed (rpm)
		@ 2300 RPM	@ 2800 RPM	@ 3200 RPM	
<b>MG-340**</b>	F: 1.45 / R: 2.13 F: 2.00 / R: 2.13 F: 2.60 / R: 2.13	F: 26 (35) / R: 9 (12) F: 21 (28) / R: 7 (9) F: 17 (23) / R: 6 (8)	F: 26 (35) / R: 9 (12) F: 26 (35) / R: 9 (12) F: 21 (28) / R: 7 (9)	F: 26 (35) / R: 9 (12) F: 26 (35) / R: 9 (12) F: 23 (31) / R: 8 (10)	4500
<b>MG-360**</b>	F: 1.55 / R: 2.00 F: 2.00 / R: 2.00 F: 2.45 / R: 2.45 F: 2.83 / R: 2.45	F: 40 (54) / R: 29 (39) F: 36 (48) / R: 29 (39) F: 29 (39) / R: 23 (31) F: 24 (33) / R: 23 (31)	F: 50 (67) / R: 35 (47) F: 44 (59) / R: 35 (47) F: 35 (47) / R: 28 (37) F: 29 (38) / R: 28 (37)	F: 56 (75) / R: 40 (54) F: 50 (67) / R: 40 (54) F: 40 (54) / R: 32 (43) F: 33 (44) / R: 32 (43)	5000
<b>MG-5005 A</b>	1.54 2.00 2.47	83 (111) 67 (90) 50 (67)	101 (136) 82 (110) 60 (81)	110 (148) 93 (125) 70 (94)	4500
<b>MG-5012 SC</b>	1.51 2.09 2.40 2.77	123 (165) 106 (142) 94 (126) 82 (110)	149 (200) 129 (173) 115 (154) 100 (134)	171 (229) 148 (198) 131 (176) 114 (153)	4500
<b>MG-5020 SC</b>	1.50, 2.04 2.50 2.94	181 (242) 145 (194) 123 (165)	220 (295) 176 (236) 150 (201)	251 (337) 201 (270) 171 (229)	4000
<b>MG-5025 A</b>	1.52, 2.09 2.40	115 (154) 100 (134)	140 (188) 123 (165)	160 (215) 140 (188)	4500
<b>MG-5055 A</b>	1.53, 2.08 2.60	214 (287) 144 (193)	261 (350) 176 (236)	298 (400) 201 (270)	4000
		<b>@ 2300 RPM</b>	<b>@ 2800 RPM</b>	<b>@ 3300 RPM</b>	
<b>MG-5050 SC*</b>	1.00, 1.11, 1.23, 1.53, 1.71, 2.04 2.45 3.00	226 (303) 226 (303) 200 (268)	272 (365) 261 (350) 231 (310)	320 (429) 281 (377) 261 (350)	3300 (5500*)
<b>MG-5050 A*</b>	1.12, 1.26, 1.50, 1.80, 2.04 2.50	226 (303) 200 (268)	272 (365) 239 (320)	320 (429) 259 (347)	3300 (5500*)
<b>MG-5050 RV*</b>	1.12, 1.26, 1.50, 1.80, 2.04 2.50	226 (303) 200 (268)	272 (365) 239 (320)	320 (429) 259 (347)	3300 (5500*)
<b>MG-5061 SC*</b>	1.15, 1.48, 1.77, 2.00 2.43 3.00	283 (380) 263 (353) 245 (329)	345 (463) 321 (430) 298 (400)	395 (530) 376 (504) 354 (475)	3300 (5500*)
<b>MG-5061 A*</b>	1.13, 1.28, 1.54, 1.75, 2.00 2.47	283 (380) 263 (353)	345 (463) 321 (430)	396 (531) 378 (507)	3300 (5500*)
<b>MG-5061 RV*</b>	1.13, 1.28, 1.54, 1.75, 2.00 2.47	283 (380) 263 (353)	345 (463) 321 (430)	396 (531) 378 (507)	3300*
<b>MG-5062 IV*</b>	1.19, 1.53, 1.83 2.07, 2.51	283 (380) 263 (353)	354 (475) 321 (430)	623 (567) 376 (504)	3300 (5500*)
		<b>@ 2300 RPM</b>	<b>@ 2500 RPM</b>	<b>@ 2800 RPM</b>	
<b>MGX-5065 SC</b> <b>MG-5065 SC</b>	1.08, 1.26, 1.47, 1.72, 2.04 2.43	393 (527) 368 (493)	425 (570) 400 (536)	474 (636) 448 (601)	3600
<b>MGX-5065 A</b> <b>MG-5065 A</b>	1.08, 1.26, 1.47, 1.72, 2.04 2.43	393 (527) 368 (493)	425 (570) 400 (536)	474 (636) 448 (601)	3600
<b>MGX-5075 SC</b> <b>MG-5075 SC</b>	1.06, 1.22, 1.33, 1.53, 1.77, 2.05 2.53 2.88	423 (567) 380 (510) 373 (500)	455 (610) 410 (550) 403 (540)	503 (675) 453 (607) 434 (582)	3500
<b>MGX-5075 A</b> <b>MG-5075 A</b>	1.06, 1.22, 1.33, 1.53, 1.77, 2.05 2.53 2.88	423 (567) 380 (510) 373 (500)	455 (610) 410 (550) 403 (540)	503 (675) 453 (607) 434 (582)	3500
<b>MGX-5075 IV</b> <b>MG-5075 IV</b>	1.03, 1.30, 1.49, 1.72, 1.99, 2.46	392 (526)	423 (567)	468 (628)	3500
<b>MG-5075 SC</b>	0.80, 0.92, 1.00, 1.16	380 (510)	410 (550)	453 (607)	3000

Important:  
See rating definitions, application information, and torsional compatibility notices on pages 34 and 35.  
Ratings shown are in SAE Horsepower (HP). Metric Horsepower equals SAE times 1.014.  
Weights are approximate and include flywheel housing adapter and flexible input coupling.

\* Consult Twin Disc for gasoline engine ratings and required transmission modifications.  
\*\*F = Forward Ratios and Ratings  
R = Reverse Ratios and Ratios

Model	Ratios	Kilowatts (Horsepower)			Maximum Speed (rpm)
		@ 2100 RPM	@ 2300 RPM	@ 2500 RPM	
MG-5085 SC	1.05, 1.22, 1.42, 1.76 1.96 2.33	416 (558) 374 (502) 343 (460)	433 (580) 410 (550) 365 (490)	459 (615) 445 (597) 388 (520)	3200
MG-5085 A	1.05, 1.22, 1.47, 1.72 2.04 2.43	416 (558) 374 (502) 343 (460)	433 (580) 410 (550) 365 (490)	459 (615) 445 (597) 388 (520)	3200
MG-5082 SC	0.98, 1.06, 1.11, 1.33, 1.53, 1.77, 2.05, 2.28 2.53 2.88	490 (657) 462 (620) 428 (574)	530 (710) 492 (660) 447 (600)	543 (728) 521 (699) 465 (624)	3200
MG-5082 A	1.06, 1.33, 1.53, 1.77, 2.05, 2.28 2.53 2.88	490 (657) 462 (620) 428 (574)	530 (710) 492 (660) 447 (600)	543 (728) 521 (699) 465 (624)	3200
MGX-5086 SC	0.98, 1.06, 1.11, 1.33, 1.53, 1.77, 2.05, 2.28 2.53 2.88	490 (657) 462 (620) 428 (574)	530 (710) 492 (660) 447 (600)	543 (728) 521 (699) 465 (624)	3200
MGX-5086 A	1.06, 1.33, 1.53, 1.77, 2.05, 2.28 2.53 2.88	490 (657) 462 (620) 428 (574)	530 (710) 492 (660) 447 (600)	543 (728) 521 (699) 465 (624)	3200
MG-5091 SC	1.17, 1.45, 1.71, 2.04 2.45 2.95	480 (643) 433 (580) 409 (548)	522 (700) 474 (635) 447 (600)	539 (723) 500 (670) 470 (630)	3000
MG-5090 A	1.45, 1.73, 1.96 2.43	484 (649) 433 (580)	530 (710) 474 (635)	539 (723) 500 (670)	3000
MGX-5095 SC MG-5095 SC	1.15, 1.27, 1.47, 1.71, 2.00, 2.46 2.95	544 (730) 510 (684)	597 (800) 560 (751)	634 (850) 608 (815)	3000
MGX-5096 A	1.28, 1.52, 1.81, 2.04 2.48	618 (829) 556 (746)	671 (900) 596 (800)	718 (963) 638 (856)	3000
MGX-5114 SC MG-5114 SC	0.93, 1.02, 1.12, 1.50, 1.74, 2.04, 2.54 3.00	619 (830) 528 (708)	673 (900) 578 (775)	716 (960) 629 (843)	2800 for 0.93:1 3000 for others
MGX-5114 SC-HD MG-5114 SC-HD	1.50, 1.74, 2.04, 2.54 3.00	619 (830) 528 (708)	673 (900) 578 (775)	716 (960) 629 (843)	3000
MGX-5114 DC MG-5114 DC	3.28, 3.43, 4.17 4.59 4.86	619 (830) 579 (776) 567 (760)	673 (900) 634 (850) 604 (810)	701 (940) 679 (911) 634 (850)	3000
MGX-5114 RV MG-5114 RV	1.03, 1.20, 1.48, 1.75, 1.92 2.04, 2.50	619 (830)	673 (900)	701 (940)	3000
MGX-5114 IV MG-5114 IV	1.05, 1.23, 1.52, 1.80, 1.98 2.57	619 (830) 599 (803)	673 (900) 649 (870)	701 (940) 677 (908)	3000
MGX-5126 A	1.03, 1.20, 1.48, 1.75, 1.92, 2.04 2.50	723 (970) 621 (933)	783 (1050) 673 (902)	816 (1094) 701 (940)	3000
MGX-5136 SC	1.00, 1.10, 1.28, 1.48, 1.73, 2.04 2.57 2.90	817 (1096) 758 (1016) 668 (896)	895 (1200) 847 (1136) 746 (1000)	954 (1279) 901 (1208) 794 (1065)	2800
MGX-5136 A	1.16, 1.25, 1.53, 1.79, 2.00 2.52	817 (1096) 758 (1016)	895 (1200) 847 (1136)	954 (1279) 901 (1208)	2800
MGX-5136 RV	1.16, 1.25, 1.53, 1.79, 2.00 2.52	817 (1096) 758 (1016)	895 (1200) 847 (1136)	954 (1279) 901 (1208)	2800
MGX-5146 SC	1.03, 1.20, 1.33, 1.48, 1.57, 1.75, 1.96 2.50	965 (1294) 1070 (1435) 875 (1173)	1045 (1401) 1142 (1531) 952 (1277)	1085 (1455) 1195 (1603) 1001 (1342)	2500
MGX-5146 A	1.26, 1.48, 1.75, 1.96 2.50	1070 (1435) 931 (1248)	1142 (1531) 1014 (1360)	1195 (1603) 1065 (1428)	2500
MGX-5146 RV	1.26, 1.48, 1.75, 1.96 2.50	1070 (1435) 931 (1248)	1142 (1531) 1014 (1360)	1195 (1603) 1065 (1428)	2500
MGX-5202 SC	1.17, 1.33, 1.53, 1.76, 2.03, 2.48, 2.92 3.48	886 (1188) 742 (995)	969 (1300) 800 (1073)	1019 (1366) 841 (1128)	2750 (2500 at 1.17:1)

Important:  
See rating definitions, application information, and torsional compatibility notices on pages 34 and 35.  
Ratings shown are in SAE Horsepower (HP). Metric Horsepower equals SAE times 1.014.  
Weights are approximate and include flywheel housing adapter and flexible input coupling.

Model	Ratios	Kilowatts (Horsepower)			Maximum Speed (rpm)
		@ 2100 RPM	@ 2300 RPM	@ 2500 RPM	
MGX-5204 SC	1.17, 1.33, 1.53, 1.76, 2.03, 2.48, 2.92 3.48	1029 (1380) 984 (1320)	1104 (1480) 1081 (1450)	1104 (1480) 1081 (1450)	2750 (2500 at 1.17:1)
MG-6449 A	1.51, 1.73, 2.07, 2.44 2.95	1007 (1350) 715 (959)	1104 (1480) 782 (1050)	1104 (1480) 782 (1050)	2500
MG-6449 RV	1.51, 1.73, 2.07, 2.44 2.95	1007 (1350) 715 (959)	1104 (1480) 782 (1050)	1104 (1480) 782 (1050)	2500
MGX-6598 DC	2.46, 3.03, 3.48 3.93 4.43	1335 (1790) 1226 (1644) 1070 (1435)	1462 (1961) 1343 (1801) 1172 (1572)	1557 (2088) 1399 (1876) 1249 (1674)	2500
MGX-6599 SC	1.07, 1.30, 1.50, 1.66 1.74, 1.97, 2.04, 2.19, 2.45 2.82	1326 (1778) 1295 (1737) 1056 (1416)	1452 (1947) 1418 (1902) 1156 (1550)	1518 (2036) 1510 (2024) 1232 (1652)	2500
MGX-6599 A	1.34, 1.51, 1.74, 2.03, 2.24, 2.48 2.80	1295 (1737) 1056 (1416)	1418 (1902) 1156 (1550)	1510 (2024) 1232 (1652)	2500
MGX-6599 RV	1.34, 1.51, 1.74, 2.03, 2.24 2.48 2.80	1295 (1737) 1226 (1644) 1056 (1416)	1418 (1902) 1343 (1801) 1156 (1550)	1510 (2024) 1431 (1919) 1232 (1652)	2500
MG-6600 DC	3.30, 4.11, 4.68, 4.72 5.21 6.05	1319 (1769) 1103 (1479) 987 (1324)	1446 (1938) 1208 (1620) 1082 (1450)	1539 (2064) 1287 (1726) 1152 (1545)	2500
MGX-6620 SC	1.15, 1.33, 1.53, 1.73, 2.03, 2.32, 2.44 2.72	1430 (1918) 1342 (1800)	1566 (2100) 1470 (1971)	1668 (2237) 1556 (2087)	2500
MGX-6620 A	1.55, 1.72, 2.09, 2.28, 2.42 2.73	1430 (1918) 1373 (1841)	1566 (2100) 1504 (2017)	1668 (2237) 1602 (2148)	2500
MGX-6620 RV	1.55, 1.72, 2.09, 2.28, 2.42 2.73	1430 (1918) 1357 (1820)	1566 (2100) 1470 (1971)	1668 (2237) 1536 (2060)	2500
MGX-6650 SC	1.51, 1.88, 2.03, 2.37 2.47, 2.81, 2.93, 3.21	1430 (1918)	1566 (2100)	1602 (2148)	2300 (1.51-2.03) 2500 (2.37-3.21)
MGX-6690 SC	1.51, 1.88, 2.03, 2.37 2.47, 2.81, 2.93, 3.21	1534 (2057)	1680 (2253)	1790 (2400)	2300 (1.51-2.03) 2500 (2.37-3.21)
MGX-6848 SC	1.51, 1.88, 2.03 2.37, 2.47 2.58, 2.93 3.21	1864 (2500) 1864 (2500) 1746 (2341) 1526 (2046)	2028 (2720) 2028 (2720) 1891(2536) 1653 (2217)	— 2147 (2879) 2001 (2682) 1748 (2343)	2300 (1.51-2.03) 2500 (2.37-3.21)
Model	Ratios	Kilowatts (Horsepower)			Maximum Speed (rpm)
		@ 1600 RPM	@ 1800 RPM	@ 2100 RPM	
MG-6984 SC	1.18, 1.54, 2.06, 2.29, 2.52 2.92 3.25 3.43	1693 (2270) 1648 (2210) 1466 (1966) 1364 (1829)	1905 (2555) 1854 (2486) 1649 (2211) 1534 (2057)	2222 (2980) 2163 (2900) 1924 (2580) 1790 (2400)	2100
MG-6984 A	1.48, 1.97, 2.50 2.79 2.93	1693 (2270) 1682 (2256) 1642 (2202)	1905 (2555) 1892 (2537) 1847 (2477)	2222 (2980) 2207 (2960) 2155 (2890)	2100
MG-6984 RV	1.48, 1.97, 2.50 2.79 2.93	1693 (2270) 1682 (2256) 1642 (2202)	1905 (2555) 1892 (2537) 1847 (2477)	2222 (2980) 2207 (2960) 2155 (2890)	2100
MGX-61000 SC	2.22, 2.54, 2.63, 2.72, 3.03, 3.39	Please contact Twin Disc			2100
MG-61242 SC	1.16, 1.52, 2.08, 2.47 2.96	2176 (2918) 2091 (2804)	2448 (3283) 2353 (3155)	2856 (3830) 2745 (3681)	2100
MG-61242 A	1.42, 2.07, 2.44 2.93	2176 (2918) 2074 (2781)	2448 (3283) 2333 (3129)	2856 (3830) 2722 (3650)	2100
MG-61242 RV	1.42, 2.07, 2.44 2.93	2176 (2918) 2074 (2781)	2448 (3283) 2333 (3129)	2856 (3830) 2722 (3650)	2100
MGX-61500 SC	1.84, 1.98, 2.26, 2.39, 2.45 2.56, 2.86, 2.97, 3.03, 3.41	Please contact Twin Disc			2100

Important:  
See rating definitions, application information, and torsional compatibility notices on pages 34 and 35.  
Ratings shown are in SAE Horsepower (HP). Metric Horsepower equals SAE times 1.014.  
Weights are approximate and include flywheel housing adapter and flexible input coupling.

Model	Ratios	Kilowatts (Horsepower)			Maximum Speed (rpm)
		@ 2300 RPM	@ 2500 RPM	@ 2800 RPM	
<b>MG-5050 SC*</b>	1.00, 1.11, 1.23, 1.53, 1.71, 2.04 2.45 3.00	211 (283) 211 (283) 187 (251)	228 (306) 216 (290) 198 (266)	254 (341) 223 (299) 216 (290)	3300 (5500*)
<b>MG-5050 A*</b>	1.12, 1.26, 1.50, 1.80, 2.04 2.50	211 (283) 187 (251)	228 (306) 204 (274)	254 (341) 223 (299)	3300 (5500*)
<b>MG-5050 RV*</b>	1.12, 1.26, 1.50, 1.80, 2.04 2.50	211 (283) 187 (251)	228 (306) 204 (274)	254 (341) 223 (299)	3300 (5500*)
<b>MG-5061 SC*</b>	1.15, 1.48, 1.77, 2.00 2.43 3.00	265 (355) 246 (330) 229 (307)	288 (386) 268 (360) 248 (333)	323 (433) 300 (402) 279 (374)	3300 (5500*)
<b>MG-5061 A*</b>	1.13, 1.28, 1.54, 1.75 2.00, 2.47	257 (345) 246 (330)	281 (377) 268 (360)	313 (420) 300 (402)	3300 (5500*)
<b>MG-5061 RV*</b>	1.13, 1.28, 1.54, 1.75 2.00, 2.47	257 (345) 246 (330)	281 (377) 268 (360)	313 (420) 300 (402)	3300*
<b>MG-5062 IV*</b>	1.19, 1.53, 1.83 2.07, 2.51	265 (355) 246 (330)	292 (392) 268 (360)	331 (444) 300 (402)	3300 (5500*)
<b>MGX-5065 SC MGX-5065 A</b>	1.08, 1.26, 1.47, 1.72, 2.04 2.43	376 (504) 351 (471)	407 (546) 381 (511)	453 (607) 428 (574)	3600
<b>MG-5065 SC</b>	1.08, 1.26, 1.47, 1.72, 2.04 2.43	376 (504) 351 (471)	407 (546) 381 (511)	453 (607) 428 (574)	3600
<b>MG-5065 A</b>	1.08, 1.26, 1.47, 1.72, 2.04 2.43	376 (504) 351 (471)	407 (546) 381 (511)	453 (607) 428 (574)	3600
<b>MGX-5075 SC MG-5075 SC</b>	1.06, 1.22, 1.33, 1.53, 1.77, 2.05 2.53 2.88	368 (493) 355 (476) 348 (467)	390 (523) 383 (514) 375 (503)	433 (581) 423 (567) 406 (544)	3500
<b>MGX-5075 A MG-5075 A</b>	1.06, 1.22, 1.33, 1.53, 1.77, 2.05 2.53 2.88	368 (493) 355 (476) 348 (467)	390 (523) 383 (514) 375 (503)	433 (581) 423 (567) 406 (544)	3500
<b>MGX-5075 IV MG-5075 IV</b>	1.03, 1.30, 1.49, 1.72, 1.99, 2.46	355 (476)	383 (514)	423 (567)	3500
<b>MG-5075 SC</b>	0.80, 0.92, 1.00, 1.16	355 (476)	383 (514)	423 (567)	3000
		<b>@ 2100 RPM</b>	<b>@ 2300 RPM</b>	<b>@ 2500 RPM</b>	
<b>MG-5085 SC</b>	1.05, 1.22, 1.42, 1.76 1.96 2.33	389 (522) 348 (467) 321 (430)	404 (542) 383 (514) 342 (459)	429 (575) 416 (558) 362 (485)	3200
<b>MG-5085 A</b>	1.05, 1.22, 1.47, 1.72 2.04 2.43	389 (522) 355 (476) 321 (430)	404 (542) 383 (514) 342 (459)	429 (575) 416 (558) 362 (485)	3200
<b>MG-5082 SC</b>	0.98, 1.06, 1.11, 1.33, 1.53, 1.77, 2.05, 2.28, 2.53 2.88	432 (579) 400 (536)	460 (617) 418 (560)	487 (653) 434 (582)	3200
<b>MG-5082 A</b>	1.06, 1.33, 1.53, 1.77, 2.05, 2.28, 2.53 2.88	432 (579) 400 (536)	460 (617) 418 (560)	487 (653) 434 (582)	3200
<b>MGX-5086 SC</b>	0.98, 1.06, 1.11, 1.33, 1.53, 1.77, 2.05, 2.28, 2.53 2.88	432 (579) 400 (536)	460 (617) 418 (560)	487 (653) 434 (582)	3200
<b>MGX-5086 A</b>	1.06, 1.33, 1.53, 1.77, 2.05, 2.28, 2.53 2.88	432 (579) 400 (536)	460 (617) 418 (560)	487 (653) 434 (582)	3200
<b>MG-5091 SC</b>	1.17, 1.45, 1.71, 2.04 2.45 2.95	429 (575) 404 (542) 382 (512)	471 (632) 442 (593) 418 (561)	495 (664) 467 (626) 439 (589)	3000
<b>MG-5090 A</b>	1.45, 1.73, 1.96 2.43	429 (575) 404 (542)	471 (632) 442 (593)	494 (662) 434 (626)	3000

Important:  
See rating definitions, application information, and torsional compatibility notices on pages 34 and 35.  
Ratings shown are in SAE Horsepower (HP). Metric Horsepower equals SAE times 1.014.  
Weights are approximate and include flywheel housing adapter and flexible input coupling.

\* Consult Twin Disc for gasoline engine ratings and required transmission modifications.

Model	Ratios	Kilowatts (Horsepower)			Maximum Speed (rpm)
		@ 2100 RPM	@ 2300 RPM	@ 2500 RPM	
<b>MGX-5095 SC</b> <b>MG-5095 SC</b>	1.15, 1.27, 1.47, 1.71, 2.00, 2.46 2.95	525 (704) 481 (645)	560 (751) 522 (700)	593 (795) 554 (743)	3000
<b>MGX-5096A</b>	1.28, 1.52, 1.81, 2.04 2.48	560 (751) 520 (697)	597 (801) 559 (750)	633 (849) 598 (802)	3000
<b>MGX-5114 SC</b> <b>MG-5114 SC</b>	0.93, 1.02, 1.12, 1.50, 1.74, 2.04, 2.54 3.00	579 (776) 494 (662)	629 (843) 540 (724)	669 (897) 588 (789)	2800 at .93:1 3000 for others
<b>MGX-5114 SC-HD</b> <b>MG-5114 SC-HD</b>	1.50, 1.74, 2.04, 2.54 3.00	579 (776) 494 (662)	629 (843) 540 (724)	669 (897) 588 (789)	3000
<b>MGX-5114 DC</b> <b>MG-5114 DC</b>	3.28, 3.43, 4.17 4.59 4.86	579 (776) 542 (727) 530 (711)	629 (843) 591 (793) 565 (758)	656 (880) 634 (850) 575 (771)	3000
<b>MGX-5114 RV</b> <b>MG-5114 RV</b>	1.03, 1.20, 1.48, 1.75, 1.92 2.04, 2.50	580 (777)	629 (843)	655 (878)	3000
<b>MGX-5114 IV</b> <b>MG-5114 IV</b>	1.05, 1.23, 1.52, 1.80, 1.98 2.57	580 (777) 560 (751)	629 (843) 607 (814)	655 (878) 632 (848)	3000
<b>MGX-5126 A</b>	1.03, 1.20, 1.48, 1.75, 1.92, 2.04 2.50	675 (905) 580 (778)	732 (982) 629 (843)	763 (1023) 656 (880)	3000
<b>MGX-5136 SC</b>	1.00, 1.10, 1.28, 1.48, 1.73, 2.04 2.57 2.90	704 (944) 663 (889) 622 (834)	746 (1000) 716 (960) 671 (900)	788 (1057) 768 (1030) 720 (966)	2800
<b>MGX-5136 A</b>	1.16, 1.25, 1.53, 1.79, 2.00 2.52	704 (944) 663 (889)	746 (1000) 716 (960)	788 (1057) 768 (1030)	2800
<b>MGX-5136 RV</b>	1.16, 1.25, 1.53, 1.79, 2.00 2.52	704 (944) 663 (889)	746 (1000) 716 (960)	788 (1057) 768 (1030)	2800
<b>MGX-5146 SC</b>	1.03, 1.20, 1.33, 1.48, 1.57, 1.75, 1.96 2.50	781 (1047) 918 (1231) 828 (1110)	846 (1134) 974 (1306) 895 (1200)	878 (1177) 1028 (1379) 961 (1289)	2500
<b>MGX-5146 A</b>	1.26, 1.48, 1.75, 1.96 2.50	918 (1231) 828 (1110)	974 (1306) 895 (1200)	1028 (1379) 961 (1289)	2500
<b>MGX-5146 RV</b>	1.26, 1.48, 1.75, 1.96 2.50	918 (1231) 828 (1110)	974 (1306) 895 (1200)	1028 (1379) 961 (1289)	2500
		@ 1800 RPM	@ 2100 RPM	@ 2300 RPM	
<b>MGX-5202 SC</b>	1.17, 1.33, 1.53, 1.76, 2.03, 2.48, 2.92 3.48	742 (995) 641 (860)	852 (1142) 731 (980)	924 (1239) 789 (1059)	2750
<b>MGX-5204 SC</b>	1.17, 1.33, 1.53, 1.76, 2.03, 2.48, 2.92 3.48	742 (995) 647 (868)	865 (1160) 764 (1025)	979 (1313) 837 (1122)	2750
<b>MG-6449 A</b>	1.51, 1.73 2.07 2.44 2.95	840 (1126) 795 (1067) 711 (953) 545 (731)	978 (1312) 912 (1223) 805 (1080) 635 (852)	1072 (1437) 974 (1306) 861 (1154) 696 (933)	2500
<b>MG-6449 RV</b>	1.51, 1.73 2.07 2.44 2.95	840 (1126) 795 (1067) 711 (953) 545 (731)	978 (1312) 912 (1223) 805 (1080) 635 (852)	1072 (1437) 974 (1306) 861 (1154) 696 (933)	2500
<b>MGX-6598 DC</b>	2.46, 3.03 3.48 3.93 4.43	1000 (1341) 1000 (1341) 952 (1277) 862 (1156)	1167 (1565) 1155 (1549) 1060 (1421) 990 (1328)	1278 (1714) 1241 (1664) 1131 (1517) 1055 (1415)	2500

Important:  
See rating definitions, application information, and torsional compatibility notices on pages 34 and 35.  
Ratings shown are in SAE Horsepower (HP). Metric Horsepower equals SAE times 1.014.  
Weights are approximate and include flywheel housing adapter and flexible input coupling.



Model	Ratios	Kilowatts (Horsepower)			Maximum Speed (rpm)
		@ 1800 RPM	@ 2100 RPM	@ 2300 RPM	
<b>MGX-6599 SC</b>	1.07, 1.30, 1.50, 1.66, 1.74	1010 (1354)	1178 (1580)	1244 (1668)	2500
	1.97, 2.04, 2.19	1001 (1342)	1167 (1565)	1234 (1655)	
	2.45	920 (1234)	1073 (1439)	1164 (1561)	
	2.82	821 (1101)	955 (1281)	1042 (1397)	
<b>MGX-6599 A</b>	1.34, 1.51, 1.74, 2.03, 2.24	1092 (1464)	1221 (1637)	1301 (1745)	2500
	2.48	935 (1254)	1091 (1463)	1195 (1602)	
	2.80	896 (1202)	1045 (1401)	1144 (1534)	
<b>MGX-6599 RV</b>	1.34, 1.51, 1.74, 2.03, 2.24	1092 (1464)	1221 (1637)	1301 (1745)	2500
	2.48	935 (1254)	1091 (1463)	1195 (1602)	
	2.80	896 (1202)	1045 (1401)	1144 (1534)	
<b>MG-6600 DC</b>	3.30, 4.11	1009 (1353)	1177 (1578)	1289 (1728)	2500
	4.68, 4.72	926 (1242)	1080 (1448)	1182 (1585)	
	5.22	818 (1097)	953 (1278)	1044 (1400)	
	6.05	722 (968)	843 (1129)	923 (1237)	
<b>MGX-6620 SC</b>	1.15	1109 (1487)	1294 (1735)	1338 (1794)	2500
	1.33, 1.53, 1.73, 2.03, 2.32, 2.44	1109 (1487)	1294 (1735)	1417 (1900)	
	2.72	1080 (1448)	1255 (1683)	1338 (1794)	
<b>MGX-6620 A</b>	1.55, 1.72, 2.09, 2.28, 2.42	1106 (1483)	1294 (1735)	1417 (1900)	2500
	2.73	1105 (1482)	1248 (1674)	1330 (1784)	
<b>MGX-6620 RV</b>	1.55, 1.72	1122 (1505)	1309 (1755)	1434 (1923)	2500
	2.09, 2.28, 2.42	1122 (1505)	1262 (1692)	1345 (1804)	
	2.73	1030 (1381)	1147 (1538)	1223 (1640)	
<b>MGX-6650 SC</b>	1.51, 1.88, 2.03, 2.37	1225 (1643)	1417 (1900)	1464 (1963)	2300 (1.51-2.03) 2500 (2.37-3.21)
	2.47, 2.93, 3.21				
<b>MGX-6690 SC</b>	1.51, 1.88, 2.03, 2.37	1225 (1643)	1417 (1900)	1464 (1963)	2300 (1.51-2.03) 2500 (2.37-3.21)
	2.47, 2.81, 2.93, 3.21				
<b>MGX-6848 SC</b>	1.51, 1.88, 2.03, 2.37, 2.47	1591 (2134)	1828 (2451)	1985 (2662)	2300 (1.51-2.03) 2500 (2.37-3.21)
	2.58, 2.81, 2.93	1483 (1989)	1699 (2278)	1841 (2469)	
	3.21	1297 (1739)	1485 (1991)	1609 (2158)	
		<b>@ 1600 RPM</b>	<b>@ 1800 RPM</b>	<b>@ 2100 RPM</b>	
<b>MG-6984 SC</b>	1.18, 1.54, 2.06, 2.29, 2.52	1614 (2164)	1816 (2435)	2119 (2842)	2100
	2.92	1528 (2049)	1719 (2305)	2006 (2690)	
	3.25	1269 (1702)	1427 (1914)	1665 (2233)	
	3.43	1180 (1582)	1328 (1781)	1549 (2077)	
<b>MG-6984 A</b>	1.48, 1.97	1602 (2148)	1802 (2416)	2102 (2819)	2100
	2.50	1552 (2081)	1746 (2341)	2037 (2732)	
	2.79	1536 (2060)	1728 (2317)	2016 (2703)	
	2.93	1512 (2028)	1701 (2281)	1984 (2661)	
<b>MG-6984 RV</b>	1.48, 1.97	1602 (2148)	1802 (2416)	2102 (2819)	2100
	2.50	1552 (2081)	1746 (2341)	2037 (2732)	
	2.79	1536 (2060)	1728 (2317)	2016 (2703)	
	2.93	1512 (2028)	1701 (2281)	1984 (2661)	
<b>MGX-61000 SC</b>	2.22, 2.54, 2.63, 2.72, 3.03, 3.39	Please contact Twin Disc			2100
<b>MG-61242 SC</b>	1.16, 1.52, 2.08	2064 (2768)	2322 (3114)	2709 (3633)	2100
	2.47	2007 (2691)	2258 (3028)	2634 (3532)	
	2.96	1950 (2615)	2193 (2941)	2559 (3432)	
<b>MG-61242 A</b>	1.42, 2.07	2090 (2803)	2351 (3153)	2743 (3678)	2100
	2.44	2007 (2691)	2258 (3028)	2634 (3532)	
	2.93	1950 (2615)	2193 (2941)	2559 (3432)	
<b>MG-61242 RV</b>	1.42, 2.07	2090 (2803)	2351 (3153)	2743 (3678)	2100
	2.44	2007 (2691)	2258 (3028)	2634 (3532)	
	2.93	1950 (2615)	2193 (2941)	2559 (3432)	
<b>MGX-61500 SC</b>	1.84, 1.98, 2.26, 2.39, 2.45 2.56, 2.86, 2.97, 3.03, 3.41	Please contact Twin Disc			2100

Important:  
See rating definitions, application information, and torsional compatibility notices on pages 34 and 35.  
Ratings shown are in SAE Horsepower (HP). Metric Horsepower equals SAE times 1.014.  
Weights are approximate and include flywheel housing adapter and flexible input coupling.

Model	Ratios	Kilowatts (Horsepower)			Maximum Speed (rpm)
		@ 2100 RPM	@ 2500 RPM	@ 2800 RPM	
<b>MG-340**</b>	F: 1.45 / R: 2.13 F: 2.00 / R: 2.13 F: 2.60 / R: 2.13	F: 24 (32) / R: 8 (10) F: 17 (23) / R: 6 (8) F: 13 (17) / R: 4 (6)	F: 26 (35) / R: 9 (12) F: 20 (27) / R: 7 (9) F: 15 (20) / R: 5 (7)	F: 26 (35) / R: 9 (12) F: 23 (31) / R: 8 (10) F: 18 (24) / R: 6 (8)	4500
<b>MG-360**</b>	F: 1.55 / R: 2.00 F: 2.00 / R: 2.00 F: 2.45 / R: 2.45 F: 2.83 / R: 2.45	F: 31 (42) / R: 22 (30) F: 28 (38) / R: 22 (30) F: 23 (31) / R: 18 (25) F: 19 (26) / R: 18 (25)	F: 36 (48) / R: 26 (35) F: 33 (44) / R: 26 (35) F: 29 (39) / R: 22 (30) F: 22 (30) / R: 22 (30)	F: 41 (55) / R: 30 (40) F: 37 (50) / R: 30 (40) F: 31 (42) / R: 25 (33) F: 25 (33) / R: 25 (33)	5000
<b>MG-5005 A</b>	1.54, 2.00 2.47	47 (63) 35 (47)	56 (75) 41 (55)	63 (85) 47 (63)	4500
<b>MG-5012 SC</b>	1.51 2.09 2.40 2.78	93 (124) 81 (108) 72 (96) 62 (84)	110 (148) 96 (129) 85 (115) 74 (100)	124 (166) 108 (144) 96 (128) 83 (111)	4500
<b>MG-5020 SC</b>	1.50, 2.04 2.50 2.94	134 (179) 107 (144) 93 (124)	159 (214) 128 (171) 110 (148)	178 (239) 143 (192) 124 (166)	4000
<b>MG-5025 A</b>	1.52, 2.09 2.40	81 (109) 69 (93)	97 (130) 82 (110)	108 (145) 92 (123)	4500
<b>MG-5055 A</b>	1.53, 2.08 2.60	147 (197) 99 (135)	175 (235) 118 (160)	196 (263) 132 (179)	4000
<b>MG-5050 SC</b>	1.00, 1.11, 1.23, 1.53, 1.71, 2.04, 2.45 3.00	157 (211) 142 (190)	187 (251) 170 (228)	209 (280) 194 (260)	3300
<b>MG-5050 A</b>	1.12, 1.26, 1.50, 1.80, 2.04, 2.50	157 (211)	187 (251)	209 (280)	3300
<b>MG-5050 RV</b>	1.12, 1.26, 1.50, 1.80, 2.04, 2.50	157 (211)	187 (251)	209 (280)	3300
<b>MG-5061 SC</b>	1.15, 1.48, 1.77, 2.00, 2.43, 3.00	201 (270)	239 (320)	261 (350)	3300
<b>MG-5061 A</b>	1.13, 1.28, 1.54, 1.75, 2.00, 2.47	201 (270)	239 (320)	261 (350)	3300
<b>MG-5061 RV</b>	1.13, 1.28, 1.54, 1.75, 2.00, 2.47	201 (270)	239 (320)	261 (350)	3300
<b>MG-5062 IV</b>	1.19, 1.53, 1.83, 2.07, 2.51	201 (270)	239 (320)	261 (350)	3300
<b>MGX-5065 SC</b>	1.08, 1.26, 1.47, 1.72, 2.04	279 (374)	329 (441)	367 (492)	3600
<b>MG-5065 SC</b>	2.43	254 (341)	302 (405)	338 (453)	
<b>MGX-5065 A</b>	1.08, 1.26, 1.47, 1.72, 2.04	279 (374)	329 (441)	367 (492)	3600
<b>MG-5065 A</b>	2.43	254 (341)	302 (405)	338 (453)	
<b>MGX-5075 SC</b>	1.06, 1.22, 1.33, 1.53, 1.77, 2.05	283 (380)	310 (416)	324 (434)	3500
<b>MG-5075 SC</b>	2.53	268 (360)	298 (400)	313 (420)	
<b>MG-5075 SC</b>	2.88	261 (350)	287 (385)	306 (410)	
<b>MGX-5075 A</b>	1.06, 1.22, 1.33, 1.53, 1.77, 2.05	283 (380)	310 (416)	324 (434)	3500
<b>MG-5075 A</b>	2.53	268 (360)	298 (400)	313 (420)	
<b>MG-5075 A</b>	2.88	261 (350)	287 (385)	306 (410)	
<b>MGX-5075 IV</b>	1.03, 1.30, 1.49, 1.72, 1.99, 2.46	268 (360)	298 (400)	313 (420)	3500
<b>MG-5075 SC</b>	0.80, 0.92, 1.00, 1.16	268 (360)	298 (400)	313 (420)	3000
<b>MG-5085 SC</b>	1.05, 1.22, 1.42, 1.76, 1.96 2.33	287 (385) 268 (360)	332 (445) 302 (405)	365 (490) 328 (440)	3200
<b>MG-5085 A</b>	1.05, 1.22, 1.47, 1.72, 2.04 2.43	287 (385) 268 (360)	332 (445) 302 (405)	365 (490) 328 (440)	3200
<b>MG-5082 SC</b>	0.98, 1.06, 1.11, 1.33, 1.53, 1.77, 2.05, 2.28, 2.53 2.88	351 (471) 340 (456)	396 (531) 384 (515)	428 (574) 415 (557)	3200
<b>MG-5082 A</b>	1.06, 1.33, 1.53, 1.77, 2.05, 2.28, 2.53 2.88	351 (471) 340 (456)	396 (531) 384 (515)	428 (574) 415 (557)	3200

Important:  
See rating definitions, application information, and torsional compatibility notices on pages 34 and 35.  
Ratings shown are in SAE Horsepower (HP). Metric Horsepower equals SAE times 1.014.  
Weights are approximate and include flywheel housing adapter and flexible input coupling.

\*\*F = Forward Ratios and Ratings  
R = Reverse Ratios and Ratios

Model	Ratios	Kilowatts (Horsepower)			Maximum Speed (rpm)
		@ 2100 RPM	@ 2500 RPM	@ 2800 RPM	
<b>MGX-5086 SC</b>	0.86, 1.06, 1.11, 1.33, 1.53, 1.77, 2.05, 2.28, 2.53 2.88	351 (471) 340 (456)	396 (531) 384 (515)	428 (574) 415 (557)	3200
<b>MGX-5086 A</b>	1.06, 1.33, 1.53, 1.77, 2.05, 2.28, 2.53 2.88	351 (471) 340 (456)	396 (531) 384 (515)	428 (574) 415 (557)	3200
<b>MG-5091 SC</b>	1.17, 1.45, 1.71, 2.04 2.45, 2.95 3.33	354 (475) 336 (450) 268 (360)	403 (540) 374 (501) 309 (415)	425 (570) 403 (540) 346 (464)	3000
<b>MG-5091 DC</b>	3.82 4.50 5.05	321 (431) 298 (400) 251 (336)	377 (506) 350 (470) 298 (400)	420 (563) 384 (515) 334 (448)	3000
<b>MG-5090 A</b>	1.45, 1.73, 1.96 2.43	343 (460) 321 (430)	365 (490) 343 (460)	382 (512) 359 (481)	3000
		<b>@ 1800 RPM</b>	<b>@ 2100 RPM</b>	<b>@ 2300 RPM</b>	
<b>MGX-5095 SC</b> <b>MG-5095 SC</b>	1.15, 1.27, 1.47, 1.71, 2.00, 2.46 2.95	368 (493) 332 (445)	410 (550) 380 (510)	438 (587) 412 (552)	3000
<b>MGX-5096 A</b>	1.28, 1.52, 1.81, 2.04 2.48	367 (492) 336 (451)	410 (550) 380 (510)	438 (587) 409 (548)	3000
<b>MGX-5114 SC</b> <b>MG-5114 SC</b>	0.93, 1.02, 1.12, 1.50, 1.74, 2.04 2.54 3.00	448 (601) 410 (550) 380 (510)	504 (676) 466 (625) 451 (605)	552 (740) 500 (671) 492 (660)	2800 at .93:1 3000 for others
<b>MGX-5114 SC-HD</b> <b>MG-5114 SC-HD</b>	1.50, 1.74, 2.04 2.54 3.00	448 (601) 410 (550) 380 (510)	504 (676) 466 (625) 451 (605)	552 (740) 500 (671) 492 (660)	3000
<b>MGX-5114 DC</b> <b>MG-5114 DC</b>	3.28, 3.43, 4.17 4.59 4.86	431 (580) 388 (520) 375 (503)	504 (676) 448 (601) 429 (575)	537 (720) 477 (640) 463 (621)	3000
<b>MGX-5114 RV</b> <b>MG-5114 RV</b>	1.03, 1.20, 1.48, 1.75, 1.92, 2.04 2.50	404 (542) 351 (471)	466 (625) 400 (536)	504 (676) 433 (581)	3000
<b>MGX-5114 IV</b> <b>MG-5114 IV</b>	1.05, 1.23, 1.52, 1.80, 1.98 2.57	404 (542) 351 (471)	466 (625) 400 (536)	504 (676) 433 (581)	3000
<b>MGX-5126 A</b>	1.03, 1.20, 1.48, 1.75, 1.92, 2.04 2.50	404 (542) 351 (471)	466 (625) 400 (536)	504 (676) 433 (581)	3000
<b>MGX-5136 SC</b>	1.00, 1.10, 1.28, 1.48, 1.73, 2.04, 2.57 2.90	529 (709) 493 (661)	560 (751) 522 (700)	600 (805) 560 (751)	2800
<b>MGX-5136 A</b>	1.16, 1.25, 1.53, 1.79, 2.00, 2.52	529 (709)	560 (751)	600 (805)	2800
<b>MGX-5136 RV</b>	1.16, 1.25, 1.53, 1.79, 2.00, 2.52	529 (709)	560 (751)	600 (805)	2800
<b>MGX-5146 SC</b>	1.03 1.03, 1.20, 1.33, 1.57, 1.75, 1.96 2.50	661 (886) 753 (1010) 615 (825)	758 (1016) 806 (1081) 702 (941)	821 (1101) 903 (1211) 760 (1019)	2500
<b>MGX-5146 A</b>	1.26, 1.48, 1.75, 1.96 2.50	753 (1010) 615 (825)	806 (1081) 702 (941)	903 (1211) 760 (1019)	2500
<b>MGX-5146 RV</b>	1.26, 1.48, 1.75, 1.96 2.50	753 (1010) 615 (825)	806 (1081) 702 (941)	903 (1211) 760 (1019)	2500
<b>MGX-516</b>	3.06 3.50 4.04 4.52 5.05 6.00	530 (711) 518 (695) 494 (662) 484 (649) 468 (628) 419 (562)	573 (768) 549 (736) 521 (699) 510 (684) 492 (660) 470 (630)	594 (797) 569 (763) 540 (724) 526 (705) 508 (681) 498 (668)	2500
<b>MGX-5170 DC</b>	3.12, 3.54, 4.06, 4.50, 5.03, 5.95 6.53, 6.95	537 (720) 467 (626)	578 (775) 545 (731)	578 (775) 561 (752)	2500
<b>MGX-5202 SC</b>	1.17, 1.33, 1.53, 1.76, 2.03, 2.48, 2.92 3.48	630 (845)	720 (966)	778 (1043)	2750 (2500 at 1.17:1)

Important:  
See rating definitions, application information, and torsional compatibility notices on pages 34 and 35.  
Ratings shown are in SAE Horsepower (HP). Metric Horsepower equals SAE times 1.014.  
Weights are approximate and include flywheel housing adapter and flexible input coupling.

Model	Ratios	Kilowatts (Horsepower)			Maximum Speed (rpm)
		@ 1800 RPM	@ 2100 RPM	@ 2300 RPM	
<b>MGX-5204 SC</b>	1.17, 1.33, 1.53, 1.76, 2.03, 2.48, 2.92 3.48	727 (975) 630 (845)	858 (1151) 720 (966)	969 (1299) 781 (1047)	2750 (2500 at 1.17:1)
<b>MGX-5222 DC</b>	4.03, 4.59, 5.04, 6.10, 6.55, 6.96	630 (845)	720 (966)	778 (1043)	2500
<b>MGX-5225 DC</b>	4.03, 4.59, 5.04, 5.57, 6.10	727 (975)	858 (1151)	869 (1165)	2500
<b>MGX-5321 DC</b>	3.35, 4.06, 4.42, 4.96, 5.46, 5.96 6.39	1044 (1400) 893 (1198)	1163 (1560) 1022 (1374)	1178 (1580) 1108 (1486)	2400
		@ 1600 RPM	@ 1800 RPM	@ 2100 RPM	
<b>MG-540 (with flexible coupling)</b>	1.93, 2.58, 2.90, 3.26 3.91	1049 (1407) 893 (1198)	1180 (1582) 1011 (1356)	– 1193 (1600)	1900 2400
	4.10, 4.60	1049 (1407)	1180 (1582)	–	1900
	5.17	1038 (1392)	1168 (1566)	1362 (1826)	2100
	6.18	867 (1163)	975 (1307)	1138 (1526)	2400
	7.00	766 (1027)	861 (1155)	1005 (1348)	2400
	7.47	718 (963)	808 (1084)	943 (1265)	2400
<b>MG-5506</b>	4.03, 4.55, 4.96, 5.44 6.00	1323 (1774) 1197 (1605)	1489 (1998) 1347 (1806)	– –	2000
<b>MGX-5600</b>	2.53, 2.98, 3.51, 4.03	1602 (2148)	1805 (2421)	2105 (2823)	2100
	4.63, 5.04	1602 (2148)	1805 (2421)	2095 (2809)	
	5.76	1598 (2143)	1760 (2360)	1770 (2374)	
	6.04	1353 (1814)	1502 (2014)	1717 (2302)	
		@ 1800 RPM	@ 2100 RPM	@ 2300 RPM	
<b>MG-6449 A</b>	1.51, 1.73	769 (1031)	897 (1203)	958 (1285)	2500
	2.07	639 (857)	746 (1000)	794 (1065)	
	2.44	555 (744)	647 (868)	692 (928)	
	2.95	496 (665)	577 (774)	617 (828)	
<b>MG-6449 RV</b>	1.51, 1.73	769 (1031)	897 (1203)	958 (1285)	2500
	2.07	639 (857)	746 (1000)	794 (1065)	
	2.44	555 (744)	647 (868)	692 (928)	
	2.95	496 (665)	577 (774)	617 (828)	
<b>MGX-6598 DC</b>	2.46, 3.03	882 (1183)	1000 (1341)	1067 (1431)	2500
	3.48	849 (1139)	945 (1267)	1008 (1352)	
	3.93	774 (1038)	861 (1155)	918 (1231)	
	4.43	722 (968)	804 (1078)	857 (1149)	
<b>MGX-6599 SC</b>	1.07, 1.30, 1.50, 1.66, 1.74, 1.97, 2.04	862 (1156)	960 (1287)	1023 (1372)	2500
	2.19, 2.45	844 (1132)	940 (1261)	1002 (1344)	
	2.82	728 (976)	811 (1088)	864 (1159)	
<b>MGX-6599 A</b>	1.34, 1.51, 1.74, 2.03, 2.24	890 (1193)	992 (1330)	1057 (1417)	2500
	2.48	841 (1128)	937 (1257)	999 (1340)	
	2.80	815 (1093)	908 (1218)	967 (1297)	
<b>MGX-6599 RV</b>	1.34, 1.51, 1.74, 2.03, 2.24	890 (1193)	992 (1330)	1057 (1417)	2500
	2.48	841 (1128)	937 (1257)	999 (1340)	
	2.80	815 (1093)	908 (1218)	967 (1297)	
<b>MG-6600 DC</b>	3.30	819 (1098)	955 (1281)	1046 (1403)	2500
	4.11	819 (1098)	955 (1281)	1018 (1365)	
	4.68, 4.72	777 (1042)	906 (1215)	966 (1295)	
	5.21	693 (929)	809 (1085)	886 (1188)	
	6.05	617 (828)	719 (964)	788 (1057)	

Important:  
See rating definitions, application information, and torsional compatibility notices on pages 34 and 35.  
Ratings shown are in SAE Horsepower (HP). Metric Horsepower equals SAE times 1.014.  
Weights are approximate and include flywheel housing adapter and flexible input coupling.

Model	Ratios	Kilowatts (Horsepower)			Maximum Speed (rpm)
		@ 1800 RPM	@ 2100 RPM	@ 2300 RPM	
MGX-6620 SC	1.15, 1.33, 1.53, 1.73	1047 (1404)	1166 (1564)	1191 (1597)	2500
	2.03	1025 (1375)	1142 (1531)	1184 (1588)	
	2.32	1019 (1366)	1136 (1523)	1184 (1588)	
	2.44	987 (1324)	1100 (1475)	1172 (1572)	
	2.72	915 (1227)	1019 (1366)	1086 (1456)	
MGX-6620 A	1.55, 1.72, 2.09	1103 (1479)	1234 (1655)	1315 (1763)	2500
	2.28, 2.42	1028 (1379)	1145 (1535)	1220 (1636)	
	2.73	910 (1220)	1014 (1360)	1080 (1448)	
MGX-6620 RV	1.55	1031 (1383)	1149 (1541)	1224 (1641)	2500
	1.72	998 (1338)	1112 (1491)	1185 (1589)	
	2.09	947 (1270)	1055 (1415)	1125 (1509)	
	2.28, 2.42	920 (1234)	1025 (1375)	1092 (1464)	
	2.73	836 (1121)	932 (1250)	993 (1332)	
MGX-6650 SC	1.51, 1.88, 2.03, 2.37 2.47, 2.93, 3.21	1069 (1434)	1268 (1700)	1386 (1859)	2300 (1.51-2.03) 2500 (2.37-3.21)
MGX-6690 SC	1.51, 1.88, 2.03, 2.37, 2.47	1201 (1611)	1380 (1851)	1438 (1928)	2300 (1.51-2.03) 2500 (2.37-3.21)
	2.81, 2.93	1201 (1611)	1318 (1767)	1386 (1859)	
	3.21	1201 (1611)	1280 (1716)	1386 (1859)	
MGX-6848 SC	1.51, 1.88, 2.03, 2.37, 2.47, 2.58, 2.81, 2.93	1342 (1800)	1566 (2100)	1715 (2300)	2300 (1.51-2.03) 2500 (2.37-3.21)
	3.21	1269 (1702)	1453 (1948)	1575 (2112)	
		@ 1600 RPM	@ 1800 RPM	@ 2100 RPM	
MG-6984 SC	1.18, 1.54, 2.06, 2.29, 2.52, 2.92	1470 (1971)	1654 (2218)	1929 (2587)	2100
	3.25	1244 (1668)	1399 (1876)	1632 (2189)	
	3.43	1000 (1341)	1125 (1509)	1313 (1761)	
MG-6984 A	1.48, 1.97, 2.50, 2.79	1504 (2017)	1692 (2269)	1974 (2647)	2100
	2.93	1462 (1961)	1645 (2206)	1919 (2573)	
MG-6984 RV	1.48, 1.97, 2.50, 2.79	1504 (2017)	1692 (2269)	1974 (2647)	2100
	2.93	1462 (1961)	1645 (2206)	1919 (2573)	
MGX-61000 SC	2.22, 2.54, 2.63, 2.72, 3.03, 3.39	Please contact Twin Disc			2100
MG-61242 SC	1.16, 1.52, 2.08	2001 (2683)	2251 (3019)	2626 (3521)	2100
	2.47	1960 (2628)	2205 (2957)	2571 (3448)	
	2.96	1949 (2614)	2193 (2941)	2559 (3432)	
MG-61242 A	1.42, 2.07	2078 (2787)	2338 (3135)	2728 (3658)	2100
	2.44, 2.93	1949 (2614)	2193 (2941)	2559 (3432)	
MG-61242 RV	1.42, 2.07	2078 (2787)	2338 (3135)	2728 (3658)	2100
	2.44, 2.93	1949 (2614)	2193 (2941)	2559 (3432)	
MGX-61500 SC	1.84, 1.98, 2.26, 2.39, 2.45 2.56, 2.86, 2.97, 3.03, 3.41	Please contact Twin Disc			2100
MGX-61500SC-HL/HR	1.84, 1.98, 2.18, 2.26, 2.56, 2.97*	Please contact Twin Disc			2100
MGX-62000SC-HL/HR	1.84, 1.98, 2.18, 2.49, 2.97*	Please contact Twin Disc			2100

Important:  
See rating definitions, application information, and torsional compatibility notices on pages 34 and 35.  
Ratings shown are in SAE Horsepower (HP). Metric Horsepower equals SAE times 1.014.  
Weights are approximate and include flywheel housing adapter and flexible input coupling.

\*Additional ratios will be made available upon request

Model	Ratios	Kilowatts (Horsepower)			Maximum Speed (rpm)
		@ 1800 RPM	@ 2100 RPM	@ 2300 RPM	
MG-5050 SC	1.00, 1.11, 1.23, 1.53, 1.71, 2.04, 2.45 3.00	115 (154) 102 (137)	128 (172) 119 (160)	140 (188) 133 (178)	3300
MG-5050 A	1.12, 1.26, 1.50, 1.80, 2.04, 2.50	115 (154)	128 (172)	140 (188)	3300
MG-5050 RV	1.12, 1.26, 1.50, 1.80, 2.04, 2.50	115 (154)	128 (172)	140 (188)	3300
MG-5061 SC	1.15, 1.48, 1.77, 2.00, 2.43 3.00	135 (181) 126 (169)	157 (211) 147 (197)	171 (229) 160 (215)	3300
MG-5061 A	1.13, 1.28, 1.54, 1.75, 2.00 2.47	135 (181) 126 (169)	157 (211) 147 (197)	171 (229) 160 (215)	3300
MG-5061 RV	1.13, 1.28, 1.54, 1.75, 2.00 2.47	135 (181) 126 (169)	157 (211) 147 (197)	171 (229) 160 (215)	3300
MG-5062 IV	1.19, 1.53, 1.83, 2.07, 2.51	135 (181)	157 (211)	171 (229)	3300
MGX-5065 SC	1.08, 1.26, 1.47, 1.72, 2.04	227 (304)	262 (351)	285 (382)	3600
MG-5065 SC	2.43	208 (279)	243 (326)	266 (357)	
MGX-5065 A	1.08, 1.26, 1.47, 1.72, 2.04	227 (304)	262 (351)	285 (382)	3600
MG-5065 A	2.43	208 (279)	243 (326)	266 (357)	
MGX-5075 SC	1.06, 1.22, 1.33, 1.53, 1.77, 2.05	205 (275)	230 (308)	246 (330)	3500
MG-5075 SC	2.53, 2.88				
MGX-5075 A	1.06, 1.22, 1.33, 1.53, 1.77, 2.05	205 (275)	230 (308)	246 (330)	3500
MG-5075 A	2.53, 2.88				
MGX-5075 IV	1.03, 1.30, 1.49, 1.72, 1.99, 2.46	205 (275)	230 (308)	246 (330)	3500
MG-5085 SC	1.05, 1.22, 1.42, 1.76, 1.96 2.33	250 (335) 225 (302)	279 (375) 254 (341)	295 (396) 271 (363)	3200
MG-5085 A	1.05, 1.22, 1.47, 1.72, 2.04 2.43	250 (335) 217 (291)	279 (375) 248 (333)	295 (396) 268 (360)	3200
MG-5082 SC	0.98, 1.06, 1.11, 1.33, 1.53, 1.77, 2.05, 2.28, 2.53 2.88	301 (404) 273 (366)	336 (451) 313 (420)	350 (469) 331 (444)	3200
MG-5082 A	1.06, 1.33, 1.53, 1.77, 2.05, 2.28, 2.53 2.88	301 (404) 273 (366)	336 (451) 313 (420)	350 (469) 331 (444)	3200
MGX-5086 SC	0.98, 1.06, 1.11, 1.33, 1.53, 1.77, 2.05, 2.28, 2.53 2.88	301 (404) 273 (366)	336 (451) 313 (420)	350 (469) 331 (444)	3200
MGX-5086 A	1.06, 1.33, 1.53, 1.77, 2.05, 2.28, 2.53 2.88	301 (404) 273 (366)	336 (451) 313 (420)	350 (469) 331 (444)	3200
MG-5091 SC	1.17, 1.45, 1.71, 2.04 2.45, 2.95 3.33	274 (368) 265 (355) 219 (293)	317 (425) 308 (413) 254 (340)	347 (465) 330 (443) 274 (368)	3000
MG-5091 DC	3.82, 4.50 5.05	262 (351) 210 (281)	303 (406) 245 (328)	330 (443) 268 (359)	3000
MG-5090 A	1.45, 1.73, 1.96 2.43	267 (358) 250 (335)	309 (415) 291 (390)	321 (430) 302 (405)	3000
MGX-5095 SC	1.15, 1.27, 1.47, 1.71, 2.00, 2.46	336 (451)	374 (502)	399 (535)	3000
MG-5095 SC	2.95	319 (428)	360 (483)	385 (516)	
MGX-5096 A	1.28, 1.52, 1.81, 2.04, 2.48	319 (428)	358 (480)	385 (516)	3000
MGX-5114 SC	0.93, 1.02, 1.12, 1.50, 1.74, 2.04, 2.54	394 (528)	451 (605)	489 (656)	2800 at .93:1 3000 for others
MG-5114 SC	3.00	361 (484)	410 (550)	443 (595)	
MGX-5114 SC-HD	1.50, 1.74, 2.04, 2.54	394 (528)	451 (605)	489 (656)	3000
MG-5114 SC-HD	3.00	361 (484)	410 (550)	443 (595)	
MGX-5114 DC	3.28, 3.43, 4.17, 4.59, 4.86	361 (484)	419 (562)	437 (586)	3000
MGX-5114 RV	1.03, 1.20, 1.48, 1.75, 1.92, 2.04	357 (479)	407 (546)	440 (590)	3000
MG-5114 RV	2.50	338 (453)	385 (516)	417 (559)	
MGX-5114 IV	1.05, 1.23, 1.52, 1.80, 1.98	357 (479)	407 (546)	440 (590)	3000
MG-5114 IV	2.57	338 (453)	385 (516)	417 (559)	
MGX-5126A	1.03, 1.20, 1.48, 1.75, 1.92, 2.04 2.50	357 (479) 338 (453)	407 (546) 385 (516)	440 (590) 417 (559)	3000

Important:  
See rating definitions, application information, and torsional compatibility notices on pages 34 and 35.  
Ratings shown are in SAE Horsepower (HP). Metric Horsepower equals SAE times 1.014.  
Weights are approximate and include flywheel housing adapter and flexible input coupling.

Model	Ratios	Kilowatts (Horsepower)			Maximum Speed (rpm)
		@ 1600 RPM	@ 1800 RPM	@ 2100 RPM	
MGX-5136 SC	1.00, 1.10, 1.28, 1.48, 1.73, 2.04, 2.57 2.90	447 (599) 413 (554)	485 (650) 448 (601)	542 (727) 500 (671)	2800
MGX-5136 A	1.16, 1.25, 1.53, 1.79, 2.00, 2.52	447 (599)	485 (650)	542 (727)	2800
MGX-5136 RV	1.16, 1.25, 1.53, 1.79, 2.00, 2.52	447 (599)	485 (650)	542 (727)	2800
MGX-5146 SC	1.03 1.03, 1.20, 1.33, 1.48, 1.57, 1.75, 1.96 2.50	577 (774) 623 (835) 500 (671)	640 (858) 671 (900) 552 (740)	714 (957) 714 (957) 631 (846)	2500
MGX-5146 A	1.26, 1.48, 1.75, 1.96 2.50	623 (835) 500 (671)	671 (900) 552 (740)	714 (957) 631 (846)	2500
MGX-5146 RV	1.26, 1.48, 1.75, 1.96 2.50	623 (835) 500 (671)	671 (900) 552 (740)	714 (957) 631 (846)	2500
MGX-516	3.06, 3.50, 4.04, 4.52, 5.05 6.00	397 (532) 365 (489)	447 (600) 406 (544)	465 (624) 425 (570)	2500
MGX-5170 DC	3.12, 3.54, 4.06, 4.50, 5.03, 5.95 6.53, 6.95	475 (637) 415 (557)	537 (720) 459 (615)	578 (775) 499 (669)	2500
MGX-5202 SC	1.17, 1.33, 1.53, 1.76, 2.03 2.48, 2.92, 3.48	540 (724)	600 (805)	678 (909)	2500
MGX-5204 SC	1.17, 1.33, 1.53, 1.76, 2.03, 2.48, 2.92 3.48	633 (849) 540 (724)	716 (960) 600 (805)	797 (1069) 678 (909)	2750 (2500 at 1.17:1)
MGX-5222 DC	4.03, 4.59, 5.04, 6.10, 6.55, 6.96	540 (724)	600 (805)	678 (909)	2500
MGX-5225 DC	4.03, 4.59, 5.04, 5.57, 6.10	644 (864)	727 (975)	787 (1055)	2500
MGX-5321 DC	3.35, 4.06, 4.42, 4.96, 5.46 5.96 6.39	928 (1244) 865 (1160) 776 (1041)	1044 (1400) 970 (1300) 863 (1157)	1069 (1434) 1035 (1388) 967 (1297)	2400
		@ 1200 RPM	@ 1600 RPM	@ 1800 RPM	
MG-540 (with flexible coupling)	1.93, 2.58, 2.90	787 (1055)	1049 (1407)	1180 (1582)	1900
	3.26	869 (1165)	1034 (1387)	1163 (1560)	2100
	3.91	648 (869)	864 (1159)	972 (1303)	2400
	4.10, 4.60	787 (1055)	1049 (1407)	1180 (1582)	1900
	5.17	774 (1038)	1032 (1384)	1161 (1557)	2100
	6.18	644 (864)	859 (1152)	966 (1295)	2400
	7.00 7.47	571 (766) 535 (717)	762 (1022) 715 (959)	857 (1149) 804 (1078)	2400 2400
MG-5506	4.03, 4.55, 4.96, 5.44 6.00	960 (1287) 869 (1165)	1281 (1718) 1159 (1554)	1441 (1932) 1304 (1749)	2000
MGX-5600	2.53, 2.98, 3.51, 4.03, 4.63, 5.04 5.76 6.04	1230 (1649) 1200 (1609) 1016 (1362)	1598 (2143) 1566 (2100) 1309 (1755)	1760 (2360) 1737 (2329) 1451 (1946)	2100

Important:  
See rating definitions, application information, and torsional compatibility notices on pages 34 and 35.  
Ratings shown are in SAE Horsepower (HP). Metric Horsepower equals SAE times 1.014.  
Weights are approximate and include flywheel housing adapter and flexible input coupling.

Model	Ratios	Kilowatts (Horsepower)			Maximum Speed (rpm)
		@ 1600 RPM	@ 1800 RPM	@ 2100 RPM	
MG-6449 A	1.51, 1.73	680 (912)	741 (994)	833 (1117)	2500
	2.07	565 (758)	617 (827)	695 (932)	
	2.44	494 (662)	537 (720)	602 (807)	
	2.95	435 (583)	489 (656)	570 (764)	
MG-6449 RV	1.51, 1.73	680 (912)	741 (994)	833 (1117)	2500
	2.07	565 (758)	617 (827)	695 (932)	
	2.44	494 (662)	537 (720)	602 (807)	
	2.95	435 (583)	489 (656)	570 (764)	
MGX-6598 DC	2.46, 3.03	759 (1018)	824 (1105)	918 (1231)	2500
	3.48	717 (961)	779 (1045)	868 (1164)	
	3.93	653 (876)	710 (952)	790 (1059)	
	4.43	609 (817)	662 (888)	737 (988)	
MGX-6599 SC	1.07, 1.30, 1.50, 1.66, 1.74, 1.97, 2.04	713 (956)	774 (1038)	862 (1156)	2500
	2.19, 2.45	713 (956)	774 (1038)	862 (1156)	
	2.82	615 (825)	668 (896)	744 (998)	
MGX-6599 A	1.34, 1.51, 1.74, 2.03, 2.24	754 (1011)	820 (1100)	910 (1220)	2500
	2.48	711 (953)	772 (1035)	860 (1153)	
	2.80	654 (877)	709 (951)	790 (1059)	
MGX-6599 RV	1.34, 1.51, 1.74, 2.03, 2.24	754 (1011)	820 (1100)	910 (1220)	2500
	2.48	711 (953)	772 (1035)	860 (1153)	
	2.80	654 (877)	709 (951)	790 (1059)	
MG-6600 DC	3.30, 4.11	663 (889)	746 (1000)	850 (1140)	2500
	4.68, 4.72	639 (857)	719 (964)	819 (1098)	
	5.22	559 (750)	629 (843)	716 (960)	
	6.05	496 (665)	558 (748)	636 (853)	
MGX-6620 SC	1.15, 1.33, 1.53, 1.73	884 (1185)	960 (1287)	998 (1338)	2500
	2.03, 2.32	861 (1155)	935 (1254)	998 (1338)	
	2.44	834 (1118)	906 (1215)	998 (1338)	
	2.72	773 (1037)	839 (1125)	935 (1254)	
MGX-6620 A	1.55, 1.72, 2.09	926 (1242)	1021 (1369)	1132 (1518)	2500
	2.28, 2.42	868 (1164)	943 (1265)	1050 (1408)	
	2.73	769 (1031)	835 (1120)	930 (1247)	
MGX-6620 RV	1.55	871 (1168)	946 (1269)	1054 (1413)	2500
	1.72	843 (1130)	915 (1227)	1020 (1368)	
	2.09	800 (1073)	869 (1165)	968 (1298)	
	2.28, 2.42	777 (1042)	844 (1132)	940 (1261)	
	2.73	707 (948)	767 (1029)	855 (1147)	
MGX-6650 SC	1.51, 1.88, 2.03, 2.37	928 (1244)	1044 (1400)	1174 (1574)	2300 (1.51-2.03)
	2.47, 2.93, 3.21				2500 (2.37-3.21)
MGX-6690 SC	1.51, 1.88, 2.03, 2.37, 2.47	1054 (1413)	1174 (1574)	1277 (1712)	2300 (1.51-2.03)
	2.81, 2.93	1034 (1387)	1144 (1534)	1209 (1621)	2500 (2.37-3.21)
	3.21	1018 (1365)	1119 (1501)	1194 (1601)	
MGX-6848 SC	1.51, 1.88, 2.03, 2.37, 2.47, 2.58, 2.81, 2.93	1187 (1592)	1342 (1800)	1566 (2100)	2300 (1.51-2.03)
	3.21	1103 (1479)	1226 (1644)	1404 (1883)	2500 (2.37-3.21)

Important:  
See rating definitions, application information, and torsional compatibility notices on pages 34 and 35.  
Ratings shown are in SAE Horsepower (HP). Metric Horsepower equals SAE times 1.014.  
Weights are approximate and include flywheel housing adapter and flexible input coupling.



Model	Ratios	Kilowatts (Horsepower)			Maximum Speed (rpm)
		@ 1200 RPM	@ 1600 RPM	@ 1800 RPM	
<b>MG-6984 SC</b>	1.18, 1.54, 2.06, 2.29, 2.52, 2.92 3.25 3.43	902 (1210) 818 (1097) 616 (826)	1203 (1613) 1090 (1462) 821 (1101)	1353 (1814) 1227 (1645) 924 (1239)	2100
<b>MG-6984 A</b>	1.48, 1.97, 2.50, 2.79 2.93	923 (1238) 887 (1189)	1230 (1649) 1182 (1585)	1384 (1856) 1330 (1784)	2100
<b>MG-6984 RV</b>	1.48, 1.97, 2.50, 2.79 2.93	923 (1238) 887 (1189)	1230 (1649) 1182 (1585)	1384 (1856) 1330 (1784)	2100
<b>MGX-61000 SC</b>	2.22, 2.54, 2.72, 3.03, 3.39	1119 (1500)	1491 (2000)	1678 (2250)	2100
<b>MG-61242 SC</b>	1.16, 1.52, 2.08, 2.47 2.96	1315 (1763) 1268 (1700)	1754 (2352) 1691 (2268)	1973 (2646) 1902 (2551)	2100
<b>MG-61242 A</b>	1.42, 2.07, 2.44 2.93	1315 (1763) 1263 (1694)	1754 (2352) 1685 (2260)	1973 (2646) 1896 (2543)	2100
<b>MG-61242 RV</b>	1.42, 2.07, 2.44 2.93	1315 (1763) 1263 (1694)	1754 (2352) 1685 (2260)	1973 (2646) 1896 (2543)	2100
<b>MGX-61500 SC</b>	1.84, 1.98, 2.45, 2.56, 2.86, 2.97 3.03, 3.41	1560 (2092) 1333 (1788)	2080 (2789) 1778 (2384)	2340 (3138) 2000 (2682)	2100

For Waterjet Propulsion Only		@ 1600 RPM	@ 1800 RPM	@ 2100 RPM	
<b>MGX-61500 SC-HL</b> <b>MGX-61500 SC-HR</b>	1.84, 1.98, 2.18, 2.26, 2.56, 2.97*	2079 (2788)	2339 (3137)	2729 (3660)	2100
<b>MGX-62000 SC-HL</b> <b>MGX-62000 SC-HL</b>	1.84, 1.98, 2.18, 2.49, 2.97*	2248 (3014)	2529 (3391)	2950 (3956)	2100

\* Additional ratios will be made available upon request

Important:  
See rating definitions, application information, and torsional compatibility notices on pages 34 and 35.  
Ratings shown are in SAE Horsepower (HP). Metric Horsepower equals SAE times 1.014.  
Weights are approximate and include flywheel housing adapter and flexible input coupling.

Model	Ratios	Kilowatts (Horsepower)			Maximum Speed (rpm)
		@ 1800 RPM	@ 2100 RPM	@ 2300 RPM	
<b>MG-340</b>	F: 1.45 / R: 2.13 F: 2.00 / R: 2.13 F: 2.60 / R: 2.13	F: 18 (24) / R: 6 (8) F: 13 (17) / R: 4 (6) F: 9 (12) / R: 3 (4)	F: 21 (28) / R: 7 (9) F: 15 (20) / R: 5 (7) F: 11 (15) / R: 4 (5)	F: 23 (31) / R: 8 (10) F: 16 (21) / R: 5 (7) F: 12 (16) / R: 4 (5)	4500
<b>MG-360</b>	F: 1.55 / R: 2.00 F: 2.00 / R: 2.00 F: 2.45 / R: 2.45 F: 2.83 / R: 2.45	F: 23 (31) / R: 17 (23) F: 21 (28) / R: 17 (23) F: 17 (23) / R: 14 (19) F: 14 (19) / R: 14 (19)	F: 26 (35) / R: 19 (26) F: 24 (32) / R: 19 (26) F: 20 (27) / R: 16 (22) F: 16 (22) / R: 16 (22)	F: 29 (39) / R: 21 (28) F: 26 (35) / R: 21 (28) F: 21 (28) / R: 17 (23) F: 17 (23) / R: 17 (23)	5000
<b>MG-5005 A</b>	1.54, 2.00 2.47	35 (47) 26 (35)	41 (55) 30 (40)	45 (60) 33 (44)	4500
<b>MG-5012 SC</b>	1.51 2.09 2.40 2.77	74 (99) 64 (86) 58 (77) 50 (67)	86 (115) 75 (100) 67 (90) 58 (78)	94 (126) 82 (110) 74 (99) 64 (86)	4500
<b>MG-5020 SC</b>	1.50, 2.04 2.50 2.94	104 (139) 83 (111) 72 (96)	121 (162) 97 (130) 84 (112)	133 (178) 106 (142) 92 (123)	4000
<b>MG-5025 A</b>	1.52, 2.09 2.40	59 (79) 52 (70)	69 (93) 61 (82)	75 (101) 67 (90)	4500
<b>MG-5055 A</b>	1.53, 2.08 2.60	105 (141) 60 (82)	123 (165) 70 (95)	135 (181) 77 (103)	4000
<b>MG-5050 SC</b>	1.00, 1.11, 1.23, 1.53, 1.71, 2.04, 2.45 3.00	104 (139) 93 (125)	116 (156) 108 (145)	127 (170) 121 (162)	3300
<b>MG-5050 A</b>	1.12, 1.26, 1.50, 1.80, 2.04, 2.50	104 (139)	116 (156)	127 (170)	3300
<b>MG-5050 RV</b>	1.12, 1.26, 1.50, 1.80, 2.04, 2.50	104 (139)	116 (156)	127 (170)	3300
<b>MG-5061 SC</b>	1.15, 1.48, 1.77, 2.00, 2.43 3.00	123 (165) 115 (154)	142 (190) 133 (178)	155 (208) 145 (194)	3300
<b>MG-5061 A</b>	1.13, 1.28, 1.54, 1.75, 2.00 2.47	123 (165) 115 (154)	142 (190) 133 (178)	155 (208) 145 (194)	3300
<b>MG-5061 RV</b>	1.13, 1.28, 1.54, 1.75, 2.00 2.47	123 (165) 115 (154)	142 (190) 133 (178)	155 (208) 145 (194)	3300
<b>MG-5062 IV</b>	1.19, 1.53, 1.83, 2.07, 2.51	123 (165)	142 (190)	155 (208)	3300
<b>MGX-5065 SC</b>	1.08, 1.26, 1.47, 1.72, 2.04 2.43	216 (290) 199 (267)	250 (335) 232 (311)	272 (365) 254 (341)	3600
<b>MGX-5065 A</b>	1.08, 1.26, 1.47, 1.72, 2.04 2.43	216 (290) 199 (267)	250 (335) 232 (311)	272 (365) 254 (341)	3600
<b>MGX-5075 SC</b>	1.06, 1.22, 1.33, 1.53, 1.77, 2.05, 2.53, 2.88	186 (249)	209 (280)	224 (300)	3500
<b>MGX-5075 A</b>	1.06, 1.22, 1.33, 1.53, 1.77, 2.05, 2.53, 2.88	186 (249)	209 (280)	224 (300)	3500
<b>MGX-5075 IV</b>	1.03, 1.30, 1.49, 1.72, 1.99, 2.46	186 (249)	209 (280)	224 (300)	3500
<b>MG-5085 SC</b>	1.05, 1.22, 1.42, 1.76, 1.96 2.33	227 (304) 205 (275)	254 (340) 231 (310)	265 (355) 243 (326)	3200
<b>MG-5085 A</b>	1.05, 1.22, 1.47, 1.72, 2.04 2.43	227 (304) 205 (275)	254 (340) 231 (310)	265 (355) 243 (326)	3200
<b>MG-5082 SC</b>	0.98, 1.06, 1.11, 1.33, 1.53, 1.77, 2.05, 2.28, 2.53, 2.88	262 (351)	292 (392)	310 (416)	3200
<b>MG-5082 A</b>	1.06, 1.33, 1.53, 1.77, 2.05, 2.28, 2.53, 2.88	262 (351)	292 (392)	310 (416)	3200
<b>MGX-5086 SC</b>	0.98, 1.06, 1.11, 1.33, 1.53, 1.77, 2.05, 2.28, 2.53, 2.88	262 (351)	292 (392)	310 (416)	3200
<b>MGX-5086 A</b>	1.06, 1.33, 1.53, 1.77, 2.05, 2.28, 2.53, 2.88	262 (351)	292 (392)	310 (416)	3200

Important:  
See rating definitions, application information, and torsional compatibility notices on pages 34 and 35.  
Ratings shown are in SAE Horsepower (HP). Metric Horsepower equals SAE times 1.014.  
Weights are approximate and include flywheel housing adapter and flexible input coupling.

\*\*F = Forward Ratios and Ratings  
R = Reverse Ratios and Ratios

Model	Ratios	Kilowatts (Horsepower)			Maximum Speed (rpm)
		@ 1800 RPM	@ 2100 RPM	@ 2300 RPM	
MG-5091 SC	1.17, 1.45, 1.71, 2.04, 2.45, 2.95 3.33	242 (325) 205 (275)	280 (375) 239 (320)	306 (410) 261 (350)	3000
MG-5091 DC	3.82, 4.50 5.05	242 (325) 205 (275)	280 (375) 239 (320)	306 (410) 261 (350)	3000
MG-5090 A	1.45, 1.73, 1.96, 2.43	239 (320)	276 (370)	287 (385)	3000
MGX-5095 SC MG-5095 SC	1.15, 1.27, 1.47, 1.71, 2.00, 2.46 2.95	298 (400)	335 (449)	360 (483)	3000
MGX-5096A	1.28, 1.52, 1.81, 2.04, 2.48	298 (400)	335 (449)	360 (483)	3000
MGX-5114 SC MG-5114 SC	0.93, 1.02, 1.12, 1.50, 1.74, 2.04, 2.54 3.00	358 (480) 328 (440)	410 (550) 373 (500)	444 (595) 403 (540)	2800 at .93:1 3000 for others
MGX-5114 SC-HD MG-5114 SC-HD	1.50, 1.74, 2.04, 2.54 3.00	358 (480) 328 (440)	410 (550) 373 (500)	444 (595) 403 (540)	3000
MGX-5114 DC MG-5114 DC	3.28, 3.43, 4.17, 4.59, 4.86	347 (465)	403 (540)	421 (565)	3000
MGX-5114 RV MG-5114 RV	1.03, 1.20, 1.48, 1.75, 1.92, 2.04 2.50	347 (465) 321 (430)	387 (519) 366 (491)	418 (561) 396 (531)	3000
MGX-5114 IV MG-5114 IV	1.05, 1.23, 1.52, 1.80, 1.98 2.57	347 (465) 321 (430)	387 (519) 366 (491)	418 (561) 396 (531)	3000
MGX-5126A	1.03, 1.20, 1.48, 1.75, 1.92, 2.04 2.50	347 (465) 321 (430)	387 (519) 366 (491)	418 (561) 396 (531)	3000
		@ 1600 RPM	@ 1800 RPM	@ 2100 RPM	
MGX-5136 SC	1.00, 1.10, 1.28, 1.48, 1.73, 2.04, 2.57 2.90	410 (550) 376 (504)	445 (597) 408 (547)	497 (666) 456 (611)	2800
MGX-5136 A	1.16, 1.25, 1.53, 1.79, 2.00, 2.52	410 (550)	445 (597)	497 (666)	2800
MGX-5136 RV	1.16, 1.25, 1.53, 1.79, 2.00, 2.52	410 (550)	445 (597)	497 (666)	2800
MGX-5146 SC	1.03, 1.20, 1.33, 1.48, 1.57, 1.75, 1.96 1.03 2.50	557 (747) 565 (758) 481 (645)	612 (821) 612 (821) 537 (720)	660 (885) 660 (885) 615 (825)	2500
MGX-5146 A	1.26, 1.48, 1.75, 1.96 2.50	565 (758) 481 (645)	612 (821) 537 (720)	660 (885) 615 (825)	2500
MGX-5146 RV	1.26, 1.48, 1.75, 1.96 2.50	565 (758) 481 (645)	612 (821) 537 (720)	660 (885) 615 (825)	2500
MGX-516	3.06, 3.50, 4.04, 4.52, 5.05 6.00	397 (532) 365 (489)	447 (600) 406 (544)	465 (624) 425 (570)	2500
MGX-5170 DC	3.12, 3.54, 4.06, 4.50, 5.03, 5.95 6.53, 6.95	448 (601) 408 (547)	507 (680) 459 (615)	541 (725) 478 (641)	2500
MGX-5202 SC	1.17, 1.33, 1.53, 1.76, 2.03, 2.48, 2.92 3.48	540 (724)	600 (805)	678 (909)	2500
MGX-5204 SC	1.17, 1.33, 1.53, 1.76, 2.03, 2.48, 2.92 3.48	633 (849) 540 (724)	716 (960) 600 (805)	797 (1069) 678 (909)	2750 (2500 at 1.17:1)
MGX-5222 DC	4.03, 4.59, 5.04, 6.10, 6.55, 6.96	540 (724)	600 (805)	678 (909)	2500
MGX-5225 DC	4.03, 4.59, 5.04, 5.57, 6.10	633 (849)	716 (960)	735 (986)	2500
MGX-5321 DC	3.35, 4.06, 4.42, 4.96, 5.46 5.96 6.39	882 (1183) 861 (1155) 737 (988)	982 (1317) 970 (1300) 812 (1089)	1000 (1341) 970 (1300) 905 (1214)	2400

Important:  
See rating definitions, application information, and torsional compatibility notices on pages 34 and 35.  
Ratings shown are in SAE Horsepower (HP). Metric Horsepower equals SAE times 1.014.  
Weights are approximate and include flywheel housing adapter and flexible input coupling.

Model	Ratios	Kilowatts (Horsepower)			Maximum Speed (rpm)
		@ 1200 RPM	@ 1600 RPM	@ 1800 RPM	
<b>MG-540</b> (with flexible coupling)	1.93, 2.58, 2.90	787 (1055)	1049 (1407)	1180 (1582)	1900
	3.26	776 (1041)	1034 (1387)	1163 (1560)	2100
	3.91	648 (869)	864 (1159)	972 (1303)	2400
	4.60	787 (1055)	1049 (1407)	1180 (1582)	1900
	5.17	774 (1038)	1032 (1384)	1161 (1557)	2100
	6.18	644 (864)	859 (1152)	969 (1300)	2400
	7.00	571 (766)	762 (1022)	895 (1200)	2400
	7.47	535 (717)	715 (959)	804 (1078)	2400
<b>MG-5506</b>	4.03, 4.55, 4.96, 5.44 6.00	937 (1257) 848 (1137)	1249 (1675) 1130 (1515)	1406 (1885) 1279 (1715)	2000
<b>MGX-5600</b>	2.53, 2.98, 3.51, 4.03, 4.63, 5.04 5.76 6.04	1230 (1649) 1200 (1609) 985 (1321)	1575 (2112) 1566 (2100) 1271 (1704)	1760 (2360) 1737 (2329) 1410 (1891)	2100
<b>MGX-5600DR</b>	4.20, 6.02 6.56 7.01 7.22	1151 (1543) 1038 (1392) 964 (1293) 845 (1133)	1564 (2097) 1458 (1955) 1352 (1813) 1088 (1459)	1760 (2360) 1641 (2201) 1566 (2100) 1207 (1619)	2100
<b>MGN-1814 V</b>	2.53, 3.00, 3.29, 3.62, 4.00 4.22	1600 (2146) 1548 (2076)	2133 (2860) 2064 (2768)	2350 (3151) 2240 (3004)	2000
<b>MGN-1816 V</b>	4.43, 4.85, 5.12, 5.33, 5.61 5.91	1600 (2146) 1500 (2012)	2133 (2860) 2000 (2682)	2350 (3151) 2240 (3004)	2000
<b>MGN-1817 V</b>	6.00, 6.56, 6.88, 7.22 7.59	1600 (2146) 1548 (2076)	2133 (2860) 2064 (2768)	2350 (3151) 2240 (3004)	2000
<b>MGN-1819 V</b>	8.04, 8.42, 8.83 9.27	1600 (2146) 1548 (2076)	2133 (2860) 2064 (2768)	2350 (3151) 2240 (3004)	2000
		@ 1600 RPM	@ 1800 RPM	@ 2100 RPM	
<b>MG-6449 A</b>	1.51, 1.73 2.07 2.44 2.95	640 (858) 529 (709) 462 (620) 413 (554)	695 (932) 574 (770) 502 (673) 448 (601)	778 (1043) 642 (861) 562 (754) 501 (672)	2500
<b>MG-6449 RV</b>	1.51, 1.73 2.07 2.44 2.95	640 (858) 529 (709) 462 (620) 413 (554)	695 (932) 574 (770) 502 (673) 448 (601)	778 (1043) 642 (861) 562 (754) 501 (672)	2500
<b>MGX-6598 DC</b>	2.46, 3.03 3.48 3.93 4.43	710 (952) 670 (898) 611 (819) 570 (764)	771 (1034) 729 (978) 664 (890) 619 (830)	858 (1151) 811 (1088) 739 (991) 690 (925)	2500
<b>MGX-6599 SC</b>	1.07, 1.30, 1.50, 1.66, 1.74 1.97, 2.04, 2.19, 2.45 2.82	685 (919) 670 (898) 575 (771)	744 (998) 728 (976) 624 (837)	828 (1110) 806 (1081) 696 (933)	2500
<b>MGX-6599 A</b>	1.34, 1.51, 1.74, 2.03, 2.24 2.48 2.80	706 (947) 668 (896) 644 (864)	767 (1029) 728 (976) 699 (937)	851 (1141) 804 (1078) 779 (1045)	2500
<b>MGX-6599 RV</b>	1.34, 1.51, 1.74, 2.03, 2.24 2.48 2.80	706 (947) 668 (896) 644 (864)	767 (1029) 728 (976) 699 (937)	851 (1141) 804 (1078) 779 (1045)	2500
<b>MG-6600 DC</b>	3.30, 4.11 4.68, 4.72 5.22 6.05	637 (854) 623 (835) 534 (716) 473 (634)	716 (960) 701 (940) 600 (805) 532 (713)	835 (1120) 818 (1097) 699 (937) 621 (833)	2500

Important:  
See rating definitions, application information, and torsional compatibility notices on pages 34 and 35.  
Ratings shown are in SAE Horsepower (HP). Metric Horsepower equals SAE times 1.014.  
Weights are approximate and include flywheel housing adapter and flexible input coupling.

Model	Ratios	Kilowatts (Horsepower)			Maximum Speed (rpm)
		@ 1600 RPM	@ 1800 RPM	@ 2100 RPM	
MGX-6620 SC	1.15, 1.33, 1.53, 1.73	827 (1109)	898 (1204)	934 (1252)	2500
	2.03	810 (1086)	879 (1179)	934 (1252)	
	2.32	805 (1080)	874 (1172)	934 (1252)	
	2.44	780 (1046)	847 (1136)	934 (1252)	
	2.72	723 (970)	785 (1053)	875 (1173)	
MGX-6620 A	1.55, 1.72, 2.09	875 (1173)	950 (1274)	1059 (1420)	2500
	2.28, 2.42	767 (1029)	833 (1117)	928 (1244)	
	2.73	719 (964)	780 (1046)	869 (1165)	
MGX-6620 RV	1.55	815 (1093)	885 (1187)	986 (1322)	2500
	1.72	788 (1057)	856 (1148)	954 (1279)	
	2.09	749 (1004)	813 (1090)	905 (1214)	
	2.28, 2.42	727 (975)	789 (1058)	879 (1179)	
	2.73	661 (886)	718 (963)	799 (1071)	
MGX-6650 SC	1.51, 1.88, 2.03, 2.37 2.47, 2.93, 3.21	911 (1222)	1025 (1375)	1098 (1472)	2300 (1.51-2.03) 2500 (2.37-3.21)
MGX-6690 SC	1.51, 1.88, 2.03, 2.37, 2.47	1017 (1364)	1129 (1514)	1195 (1602)	2300 (1.51-2.03) 2500 (2.37-3.21)
	2.81, 2.93	977 (1310)	1069 (1434)	1130 (1515)	
	3.21	943 (1265)	1028 (1379)	1098 (1472)	
MGX-6848 SC	1.51, 1.88, 2.03, 2.37, 2.47, 2.58, 2.81, 2.93	1111 (1490)	1250 (1676)	1420 (1904)	2300 (1.51-2.03) 2500 (2.37-3.21)
	3.21	1074 (1440)	1194 (1601)	1350 (1810)	
		@ 1200 RPM	@ 1600 RPM	@ 1800 RPM	
MG-6984 SC	1.18, 1.54, 2.06, 2.29, 2.52, 2.92	884 (1185)	1178 (1580)	1326 (1778)	2100
	3.25	800 (1073)	1066 (1430)	1200 (1609)	
	3.43	602 (807)	802 (1075)	903 (1211)	
MG-6984 A	1.48, 1.97, 2.50, 2.79	905 (1214)	1206 (1617)	1356 (1818)	2100
MG-6984 RV	2.93	867 (1163)	1157 (1552)	1301 (1745)	2100
	1.48, 1.97, 2.50, 2.79	905 (1214)	1206 (1617)	1356 (1818)	
MGX-61000 SC	2.22, 2.54, 2.63, 2.72, 3.03, 3.39	Please contact Twin Disc			2100
MG-61242 SC	1.16, 1.52	1250 (1676)	1667 (2235)	1875 (2514)	2100
	2.08, 2.47, 2.96	1173 (1573)	1512 (2028)	1760 (2360)	
MG-61242 A	1.49, 2.08	1239 (1661)	1651 (2214)	1858 (2492)	2100
	2.44	1189 (1594)	1585 (2125)	1782 (2390)	
	2.93	1173 (1573)	1565 (2099)	1760 (2360)	
	1.49, 2.08	1239 (1661)	1651 (2214)	1858 (2492)	
MG-61242 RV	2.44	1189 (1594)	1585 (2125)	1782 (2390)	2100
	2.93	1173 (1573)	1565 (2099)	1760 (2360)	
	1.84, 1.98, 2.26, 2.39, 2.45	Please contact Twin Disc			
MGX-61500 SC	2.56, 2.86, 2.97, 3.03, 3.41	Please contact Twin Disc			2100
MGX-61500SC-HL/HR	1.84, 1.98, 2.18, 2.26, 2.56, 2.97*	Please contact Twin Disc			2100
MGX-62000SC-HL/HR	1.84, 1.98, 2.18, 2.49, 2.97*	Please contact Twin Disc			2100

Important:  
See rating definitions, application information, and torsional compatibility notices on pages 34 and 35.  
Ratings shown are in SAE Horsepower (HP). Metric Horsepower equals SAE times 1.014.  
Weights are approximate and include flywheel housing adapter and flexible input coupling.

# DIMENSIONS AND WEIGHTS FOR TWIN DISC MARINE TRANSMISSIONS

**(A) Vertical Offset**

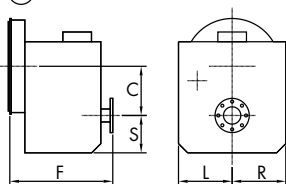

**(B) Vertical Offset Downangle**

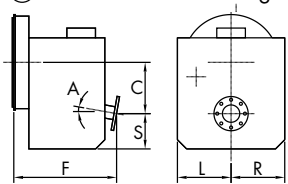

**(C) Remote V-Drive**

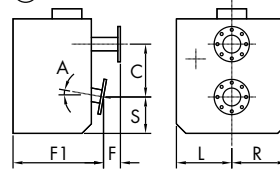

**(D) Integral V-Drive**

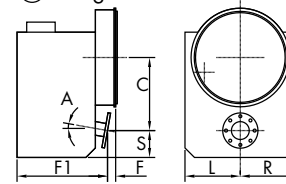

Model	Assembly Drawing	Installation Drawing Series	Con-fig.	SAE Housing	A	C (offset in (mm))
MG-340	IT101317501	IT40TD0004	A	5, BW	—	2.66 (68)
MG-360	IT101319505	IT60TD0004	A	5, BW	—	3.10 (79)
MG-5005 A	IT345ATD0001	IT1023041	B	3, 4, 5	8°	4.37 (111)
MG-5012 SC	IT1013079B01	IT93TD0001	A	3, 4, BW	—	4.35 (110)
MG-5020 SC	IT1013049B01	IT170TD0001	A	3, 4, BW	—	5.18 (132)
MG-5025 A	IT1013170	IT485ATD0000	B	3, 4, BW	8°	4.96 (126)
MG-5055 A	IT101316101	IT880ATD0002	B	3, 4, BW	10°	6.10 (155)
MG-5050 SC	PX-12700	PX-13021	A	1, 2, 3, 4	—	5.28 (134)
MG-5050 A	PX-12730	PX-13019	B	1, 2, 3, 4	10°	5.52 (140)
MG-5050 RV	PX-8760	PX-8760	C	—	10°	5.52 (140)
MG-5061 SC	PX-11650/-A	1026328	A	1, 2, 3	—	5.66 (144)
MG-5061 A	PX-11640/-A	1026225	B	1, 2, 3	7°	5.75 (146)
MG-5061 RV	PX-8735	PX-8735	C	—	7°	5.75 (146)
MG-5062 IV	PX-11660/-A	PX-11660/-A	D	1, 2, 3	15°	13.03 (331)
MGX-5065 SC	PX-12410-A	1026371	A	1, 2, 3	—	6.00 (152)
MGX-5065 A	PX-12370-A	1026215	B	1, 2, 3	7°	6.69 (170)
MG-5065 SC	PX-11480-A	1026372-A	A	1, 2, 3	—	6.00 (152)
MG-5065 A	PX-11165-B	1026552	B	1, 2, 3	7°	6.69 (170)
MGX-5075 SC	PX-12620	PX-13174	A	1, 2, 3	—	0.59 (15)
MGX-5075 A	PX-12610	PX-12610	B	1, 2, 3	7°	1.91 (48)
MGX-5075 IV	PX-12630	1026838	D	1, 2, 3	15°	14.70 (373)
MG-5075 SC	PX-11876 & PX-11876	1026311	A	1, 2, 3	—	0.59 (15)
MG-5075 SC	PX-10680/-A	PX-10680/-A	A	1, 2, 3	—	0.59 (15)
MG-5075 A	PX-10700/-A	1026876	B	1, 2, 3	7°	1.91 (48)
MG-5075 IV	PX-11530A	PX-13054	D	1, 2, 3	15°	14.70 (373)
MG-5082 SC	PX-11250-A	PX-11250-A	A	1, 2	—	0.59 (15)
MG-5082 A	PX-11040-B	PX-11040-B	B	1, 2	7°	2.12 (54)
MG-5085 SC	PX-9260-B/-C	PX-9260-B/-C	A	1, 2, 3	—	6.00 (152)
MG-5085 A	PX-9360-B/-C	PX-13370	B	1, 2, 3	7°	6.69 (170)
MGX-5086 SC	PX-12600	PX-12600	A	1, 2	—	0.59 (15)
MGX-5086 A	PX-12290	PX-13064	B	1, 2	7°	2.12 (54)
MG-5091 SC	PX-10016	1026295	A	1, 2	—	6.82 (173)
MG-5091 DC	1002155/ PX-12636 (FS)	1026877/ PX-12636 (FS)	A	1, 2	—	9.49 (241)
MG-5090 A	PX-10015	PX-13290	B	1, 2	7°	7.30 (185)
MGX-5095 SC	PX-12480A	PX-13023	A	1, 2	—	7.48 (190)
MG-5095 A	PX-13080	PX-13215	A	1, 2	—	7.48 (190)
MGX-5096A	PX12680A	PX12820	B	1, 2	7°	7.51 (191)
MG-5096A	PX13225	PX13226	B	1, 2	7°	7.51 (191)

S (sump in (mm))	F (length in (mm))	F1 (length in (mm))	L (mounting pad in (mm))	R (mounting pad in (mm))	Weight lb (kg)
2.46 (63)	7.17 (182)	—	—	2.95 (75)	20 (9)
3.56 (83)	9.65 (245)	—	—	—	31 (14)
3.19 (81)	8.82 (224)	—	—	—	55 (25)
4.92 (125)	10.14 (258)	—	6.61 (168)	6.61 (168)	117 (53)
5.17 (131)	10.53 (268)	—	7.60 (193)	7.60 (193)	165 (75)
3.43 (87)	10.63 (270)	—	6.50 (165)	6.50 (165)	79 (36)
4.25 (108)	10.51 (267)	—	7.60 (193)	7.60 (193)	119 (54)
4.69 (119)	12.78 (325)	—	8.13 (207)	5.85 (149)	189 (86)
3.68 (93)	12.10 (307)	—	8.13 (207)	5.85 (149)	176 (80)
3.68 (93)	3.06 (78)	10.13 (257)	8.13 (207)	5.85 (149)	160 (73)
4.84 (123)	13.18 (335)	—	8.40 (213)	6.15 (156)	215 (98)
4.21 (107)	12.53 (318)	—	8.40 (213)	6.16 (156)	210 (95)
4.21 (107)	2.79 (71)	10.53 (267)	8.40 (213)	6.16 (156)	190 (86)
3.97 (101)	4.00 (102)	12.92 (328)	8.40 (213)	6.15 (156)	312 (142)
5.22 (133)	13.30 (338)	—	10.00 (254)	6.50 (165)	244 (111)
4.84 (123)	12.97 (329)	—	10.00 (254)	6.50 (165)	244 (111)
5.22 (133)	13.30 (338)	—	10.00 (254)	6.50 (165)	244 (111)
4.84 (123)	12.97 (329)	—	10.00 (254)	6.50 (165)	244 (111)
7.00 (178)	14.11 (358)	—	10.00 (254)	10.00 (254)	268 (122)
7.00 (178)	13.80 (350)	—	10.00 (254)	10.00 (254)	268 (122)
3.93 (100)	2.81 (71)	13.94 (354)	10.00 (254)	10.00 (254)	330 (150)
7.00 (178)	14.11 (358)	—	10.00 (254)	10.00 (254)	268 (122)
7.00 (178)	13.80 (350)	—	10.00 (254)	10.00 (254)	268 (122)
3.93 (100)	2.81 (71)	13.94 (354)	10.00 (254)	10.00 (254)	330 (150)
7.00 (178)	16.24 (413)	—	10.00 (254)	10.00 (254)	298 (135)
7.00 (178)	15.97 (405)	—	10.00 (254)	10.00 (254)	298 (135)
5.25 (133)	14.67 (373)	—	10.00 (254)	6.50 (165)	265 (120)
4.84 (123)	14.69 (373)	—	10.00 (254)	6.50 (165)	270 (123)
7.00 (178)	16.24 (413)	—	10.00 (254)	10.00 (254)	298 (135)
7.00 (178)	15.97 (405)	—	10.00 (254)	10.00 (254)	298 (135)
6.22 (158)	16.59 (421)	—	10.25 (260)	6.94 (176)	485 (220)
9.60 (244)	18.09 (459)	—	11.12 (282)	11.12 (282)	655 (297)
5.05 (128)	17.07 (434)	—	10.25 (260)	7.00 (178)	475 (215)
6.14 (156)	17.00 (432)	—	10.43 (265)	10.43 (265)	440 (200)
6.14 (156)	17.00 (432)	—	10.43 (265)	10.43 (265)	419 (190)
5.45 (139)	19.76 (502)	—	10.43 (265)	10.43 (265)	440 (200)
5.45 (139)	19.76 (502)	—	10.43 (265)	10.43 (265)	416 (189)

Important:  
See rating definitions, application information, and torsional compatibility notices on pages 34 and 35.  
Ratings shown are in SAE Horsepower (HP). Metric Horsepower equals SAE times 1.014.  
Weights are approximate and include flywheel housing adapter and flexible input coupling.

Use certified drawings for installation.  
Dry weights are approximate and vary by input and ratio.  
Specifications are subject to change without notice.  
Dimensions may vary with housing adapter or output flange.

## DIMENSIONS AND WEIGHTS FOR TWIN DISC MARINE TRANSMISSIONS

**(A) Vertical Offset**

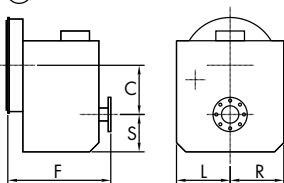

**(B) Vertical Offset Downangle**

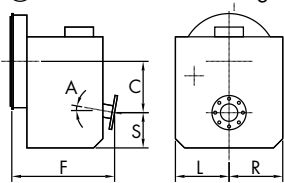

**(C) Remote V-Drive**

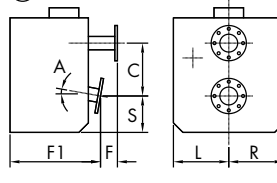

**(D) Integral V-Drive**

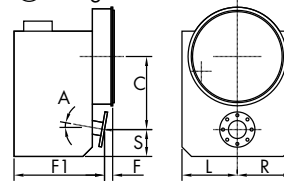

Model	Assembly Drawing	Installation Drawing Series	Con-fig.	SAE Housing	A	C (offset in (mm))
MGX-5114 SC	PX-13160	PX-13254	A	1	—	7.47 (190)
MGX-5114 SC-HD	PX-13165	PX-13252	A	1	—	7.47 (190)
MGX-5114 DC	PX-13190	PX-13298	A	1	—	10.90 (277)
MGX-5114 RV	PX-13270	PX-13365	C	—	7°	8.00 (203)
MGX-5114 IV	PX-13200	1025008	D	1, 2	14°	16.26 (413)
MG-5114 SC	PX-13150	PX-13253	A	1	—	7.47 (190)
MG-5114 SC-HD	PX-13155	PX-13251	A	1, Ind.	—	7.47 (190)
MG-5114 DC	PX-13180	PX-13297	A	1, Ind.	—	10.90 (277)
MG-5114 RV	PX-13280	PX-13366	C	—	7°	8.00 (203)
MG-5114 IV	PX-13210	PX-13359	D	1, 2	14°	16.26 (413)
MGX-5126 A	PX12870	1026597	B	1	7°	8.11 (206)
MG-5126 A	PX13235	PX13236	B	1	7°	8.11 (206)
MGX-5136SC	1027445	1027608	A	1, 0	—	7.87 (200)
MGX-5136A	1025600	1027607	B	1, 0	10°	9.12 (232)
MGX-5136RV	1027556	1027609	C	—	10°	9.12 (232)
MG-5136SC	1027560	1027762	A	1, 0	—	7.87 (200)
MG-5136A	1027557	1027761	B	1, 0	10°	9.12 (232)
MG-5136RV	1027561	1027763	C	—	10°	9.12 (232)
MGX-5146SC	1027661	1027662	A	1, 0	—	8.12 (206)
MGX-5146A	1027596	1027597	B	1, 0	10°	10.40 (264)
MGX-5146RV	1027740	1027741	C	—	10°	10.40 (264)
MG-5146SC	1027904	1027905	A	1, 0	—	8.12 (206)
MG-5146A	1027902	1027903	B	1, 0	10°	10.40 (264)
MG-5146RV	1027906	1027907	C	—	10°	10.40 (264)
MGX-516	1023380	1026197	A	1, 0 (14" only)	—	13.29 (338)
MGX-5170 DC	1023382	1026199	A	1, 0	—	15.15 (385)
MGX-5202 SC	1026316	1026322	A	1, 0, Ind.	—	9.75 (248)
MGX-5204 SC	1026193	1026242	A	1, 0, Ind.	—	9.75 (248)
MGX-5222 DC	1022822-A	1025541	A	1, 0, Ind.	—	15.75 (400)
MGX-5225 DC	1022825-A	1025541	A	1, 0, Ind.	—	15.75 (400)
MGX-5321 DC	1022203-B	1026064	A	0, 00, Ind.	—	17.32 (440)

S (sump in (mm))	F (length in (mm))	F1 (length in (mm))	L (mounting pad in (mm))	R (mounting pad in (mm))	Weight lb (kg)
6.33 (161)	19.00 (483)	—	11.00 (279)	7.50 (191)	474 (215)
6.33 (161)	19.00 (483)	—	11.00 (279)	11.00 (279)	630 (286)
9.85 (250)	19.03 (483)	—	11.25 (286)	11.25 (286)	868 (394)
5.25 (133)	2.12 (54)	17.69 (449)	11.00 (279)	8.00 (203)	435 (198)
5.75 (146)	2.43 (62)	19.26 (489)	7.50 (191)	11.50 (292)	595 (270)
6.33 (161)	19.00 (483)	—	11.00 (279)	7.50 (191)	463 (210)
6.33 (161)	19.00 (483)	—	11.00 (279)	11.00 (279)	619 (281)
9.85 (250)	19.03 (483)	—	11.25 (286)	11.25 (286)	841 (382)
5.25 (133)	2.12 (54)	17.69 (449)	11.00 (279)	8.00 (203)	435 (198)
5.75 (146)	2.43 (62)	19.26 (489)	7.50 (191)	11.50 (292)	566 (257)
5.13 (130)	21.53 (547)	—	11.00 (279)	8.00 (203)	531 (241)
5.13 (130)	21.53 (547)	—	11.00 (279)	8.00 (203)	513 (233)
7.48 (190)	22.52 (572)	—	12.01 (305)	12.01 (305)	650 (295)
6.26 (159)	21.93 (557)	—	12.01 (305)	12.01 (305)	661 (300)
6.26 (159)	4.46 (113)	18.02 (458)	12.01 (305)	12.01 (305)	588 (267)
7.48 (190)	22.52 (572)	—	12.01 (305)	12.01 (305)	634 (288)
6.26 (159)	21.93 (557)	—	12.01 (305)	12.01 (305)	645 (293)
6.26 (159)	4.46 (113)	18.02 (458)	12.01 (305)	12.01 (305)	573 (260)
7.04 (179)	22.52 (572)	—	12.01 (305)	12.01 (305)	758 (344)
6.13 (156)	21.85 (555)	—	12.01 (305)	12.01 (305)	780 (354)
6.13 (156)	5.68 (144)	17.96 (456)	12.01 (305)	12.01 (305)	700 (318)
7.04 (179)	22.52 (572)	—	12.01 (305)	12.01 (305)	747 (339)
6.13 (156)	21.85 (555)	—	12.01 (305)	12.01 (305)	771 (350)
6.13 (156)	5.68 (144)	17.96 (456)	12.01 (305)	12.01 (305)	692 (314)
12.77 (324)	20.59 (523)	—	14.00 (356)	14.00 (356)	1580 (717)
14.23 (361)	22.55 (573)	—	15.00 (381)	15.00 (381)	1670 (759)
8.75 (222)	23.45 (595)	—	14.75 (375)	10.50 (267)	1275 (580)
8.75 (222)	23.43 (595)	—	14.75 (375)	10.50 (267)	900 (409)
15.13 (384)	25.08 (637)	—	16.00 (406)	16.00 (406)	2304 (1046)
15.13 (384)	25.08 (637)	—	16.00 (406)	16.00 (406)	2304 (1046)
16.77 (426)	29.83 (758)	—	17.32 (440)	17.32 (440)	3864 (1754)

**Important:**  
See rating definitions, application information, and torsional compatibility notices on pages 34 and 35.  
Ratings shown are in SAE Horsepower (HP). Metric Horsepower equals SAE times 1.014.  
Weights are approximate and include flywheel housing adapter and flexible input coupling.

Use certified drawings for installation.  
Dry weights are approximate and vary by input and ratio.  
Specifications are subject to change without notice.  
Dimensions may vary with housing adapter or output flange.

# DIMENSIONS AND WEIGHTS FOR TWIN DISC MARINE TRANSMISSIONS

**(A) Vertical Offset**

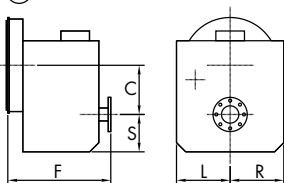

**(B) Vertical Offset Downangle**

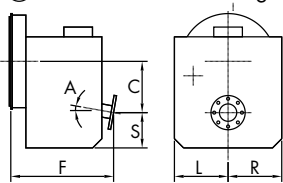

**(C) Remote V-Drive**

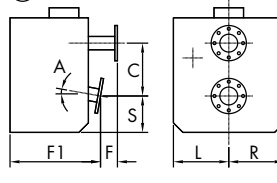

**(D) Integral V-Drive**

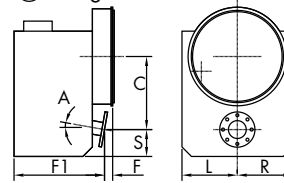

Model	Assembly Drawing	Installation Drawing Series	Config.	SAE Housing	A	C (offset) in (mm)
MG-540	X-9882-C	X-9882-C	A	0, 00, Ind.	—	8.08 (205)
MG-5506	00D005604	00D005604	A	0, 00, Ind.	—	19.29 (490)
MGX-5600	1027251	1027247	A	0, 00, Ind.	—	21.65 (550)
MGX-5600 DR	1028410	1028499	A	Ind.	—	8.85 (225)
MGN-1814 V	PPD007097	PPD007097	A	Ind.	—	16.73 (425)
MGN-1816 V	PPD007098	PPD007098	A	Ind.	—	21.26 (540)
MGN-1817 V	00D007099-B	00D007099-B	A	Ind.	—	26.38 (670)
MGN-1819 V	PLN005679-B	PLN005679-B	A	Ind.	—	30.71 (780)
MG-6449 A	5-50006-B	7-38504-A	B	1, 0, Ind.	10°	10.83 (275)
MG-6449 RV	7-37431-A	7-37431-A	C	—	10°	10.88 (276)
MGX-6598 DC	7-40985	see 1025433	A	1, 0, Ind.	—	12.20 (310)
MGX-6599 SC	7-40979	7-40989	A	1, 0, Ind.	—	8.66 (220)
MGX-6599 A	7-40981	7-40987	B	1, 0, Ind.	10°	11.70 (297)
MGX-6599 RV	7-40983	7-40988	C	—	10°	11.70 (297)
MG-6600 DC	7-37941	7-36712-A	A	0, Ind.	—	14.17 (360)
MGX-6620 SC	7-40980	see 1025433	A	0, Ind.	—	9.25 (235)
MGX-6620 A	7-40982	see 1025433	B	0, Ind.	10°	12.44 (316)
MGX-6620 RV	7-40984	see 1025433	C	—	10°	12.44 (316)
MGX-6650 SC	1002046	1028862	A	0, 00, Ind.	—	12.21 (310)
MGX-6690 SC	1020674	1025142	A	0, 00, Ind.	—	12.21 (310)
MGX-6848 SC	1020675	1025142	A	0, 00, Ind.	—	12.21 (310)
MG-6984 SC	7-37482	7-38495	A	0, 00, Ind.	—	12.21 (310)
MG-6984 A	7-37950-A	7-37028	B	0, 00, Ind.	10°	15.04 (382)
MG-6984 RV	7-37042	7-37042	C	—	10°	15.04 (382)
MGX-61000 SC	1024420	1024771	A	00, Ind.	—	14.96 (380)
MG-61242 SC	7-37018	see 1025433	A	Ind.	—	13.39 (340)
MG-61242 A	7-37047	7-37046	B	Ind.	10°	17.52 (445)
MG-61242 RV	7-37050	7-37049	C	—	10°	17.52 (445)
MGX-61500 SC	1024500	1025454	A	Ind.	—	18.11 (460)
MGX-61500 SC-HL	1023610	1025259	E	Ind.	—	18.11 (460)
MGX-61500 SC-HR	1023611	1025260	F	Ind.	—	18.11 (460)
MGX-62000 SC-HL	1026779	1025259	E	Ind.	—	18.11 (460)
MGX-62000 SC-HR	1026776	1025260	F	Ind.	—	18.11 (460)

S (sump) in (mm)	F (length) in (mm)	F1 (length) in (mm)	L (mounting pad) in (mm)	R (mounting pad) in (mm)	Weight lb (kg)
13.45 (342)	36.47 (926)	—	16.00 (406)	16.00 (406)	4450 (2019)
19.29 (490)	39.17 (995)	—	20.08 (510)	20.08 (510)	4846 (2200)
21.26 (540)	41.02 (1042)	—	20.67 (525)	20.67 (525)	6890 (3132)
21.26 (540)	50.63 (1286)	—	20.67 (525)	20.67 (525)	7000 (3175)
19.69 (500)	55.12 (1400)	—	27.56 (700)	23.62 (600)	6608 (3000)
22.83 (580)	55.12 (1400)	—	29.53 (750)	29.53 (750)	8370 (3800)
27.56 (700)	55.12 (1400)	—	31.50 (800)	31.50 (800)	9912 (4500)
33.46 (850)	55.12 (1400)	—	37.40 (950)	37.40 (950)	TBA (TBA)
4.92 (125)	20.83 (529)	—	12.01 (305)	12.01 (305)	757 (344)
6.44 (164)	6.32 (161)	20.32 (516)	12.01 (305)	12.01 (305)	782 (355)
10.83 (275)	23.72 (603)	—	14.17 (360)	14.17 (360)	1278 (580)
9.29 (236)	23.31 (592)	—	13.39 (340)	13.39 (340)	1084 (492)
6.25 (159)	22.60 (574)	—	13.39 (340)	13.39 (340)	1075 (488)
6.25 (159)	6.06 (154)	20.63 (524)	13.39 (340)	13.39 (340)	1031 (468)
14.96 (380)	30.87 (784)	—	14.76 (375)	14.76 (375)	1747 (794)
9.25 (235)	27.48 (698)	—	13.39 (340)	13.39 (340)	1267 (575)
7.25 (184)	25.70 (653)	—	13.39 (340)	13.39 (340)	1278 (580)
7.25 (184)	5.06 (129)	23.74 (603)	13.39 (340)	13.39 (340)	1123 (510)
11.81 (300)	30.13 (765)	—	17.32 (440)	17.32 (440)	2205 (1001)
11.81 (300)	30.13 (765)	—	17.32 (440)	17.32 (440)	2205 (1001)
11.81 (300)	30.13 (765)	—	17.32 (440)	17.32 (440)	2205 (1001)
11.30 (287)	27.20 (691)	—	17.52 (445)	17.52 (445)	2628 (1192)
8.50 (216)	26.93 (684)	—	17.52 (445)	17.52 (445)	1991 (905)
8.50 (216)	11.82 (300)	30.86 (784)	17.52 (445)	17.52 (445)	2002 (910)
14.17 (360)	39.08 (993)	—	19.29 (490)	19.29 (490)	3920 (1780)
12.17 (309)	29.80 (757)	—	19.69 (500)	19.69 (500)	2310 (1050)
9.49 (241)	30.35 (771)	—	19.69 (500)	19.69 (500)	2431 (1105)
9.49 (241)	11.34 (288)	32.56 (827)	19.69 (500)	19.69 (500)	2475 (1125)
15.63 (397)	40.63 (1032)	—	18.23 (463)	18.23 (463)	4230 (1920)
24.36 (619)	40.04 (1017)	—	15.63 (397)	29.33 (745)	4840 (2195)
24.36 (619)	40.04 (1017)	—	29.33 (745)	15.63 (397)	4840 (2195)
24.36 (619)	40.04 (10.17)	—	15.63 (397)	29.33 (745)	4840 (2195)
24.36 (619)	40.04 (10.17)	—	29.33 (745)	15.63 (397)	4840 (2195)

Important:  
See rating definitions, application information, and torsional compatibility notices on pages 34 and 35.  
Ratings shown are in SAE Horsepower (HP). Metric Horsepower equals SAE times 1.014.  
Weights are approximate and include flywheel housing adapter and flexible input coupling.

Use certified drawings for installation.  
Dry weights are approximate and vary by input and ratio.  
Specifications are subject to change without notice.  
Dimensions may vary with housing adapter or output flange.



## VETH Z-DRIVE SPECIFICATIONS

### TYPE OF NOZZLE

Veth Propulsion uses two types of nozzles: VG40 and VOB50 (optimized nozzle 19A).

VOB 50 is often used with tug- and push boats. The Bollard Pull efficiency is 2-3% higher than a VG40 nozzle. VG40 is recommended when high thrust at higher speeds and sailing performances are relevant.

### TYPE OF PROPELLER

For speeds of 12-14 knots, an open propeller is a better choice than a nozzleed propeller. Contra-rotating (CR) propellers are an excellent option with regard to efficiency (at different speeds) for vessels with a top speed between 10-20 knots which require a low noise level. The propellers can be used for various applications such as megayachts, ferries and passenger vessels. The CR propellers are a combination of high-efficiency, small propeller diameters and low-noise propulsion.

## THRUSTER FOUNDATION

### RIGID WELDED SUSPENSION

The thruster can be welded into the hull of the vessel; all foundation elements will be welded as an integrated part of the vessel.

### RIGID BOLTED SUSPENSION

The thrusters can be built into the vessel on a rigid suspension foundation, where the thruster is bolted directly onto the bottom well.

### FLEXIBLE SUSPENSION

The thrusters can be mounted in a flexible suspension bottom well to suppress noise and vibration when operating. To create a flexible suspension, rubber isolation rings are inserted between the thruster foundation and the bottom well.

## ACTIVE NOISE SUPPRESSION (ANS)

One of Veth Propulsion's solutions to keeping tunnel thruster noise levels to a minimum, besides flexible mounting of the thrusters, is by employing Active Noise Suppression by means of compressed air injection. Compressed air is injected into the thruster's tunnel in front of the propeller's direction of flow, thus minimizing the effects of cavitation.

ANS is a cost-effective way to decrease noise levels and cavitation damage in practically all new and existing tunnel thruster designs. Extensive testing has resulted in noise reductions up to 10 dB.

### System activation - compressed air injected into tunnel's water flow

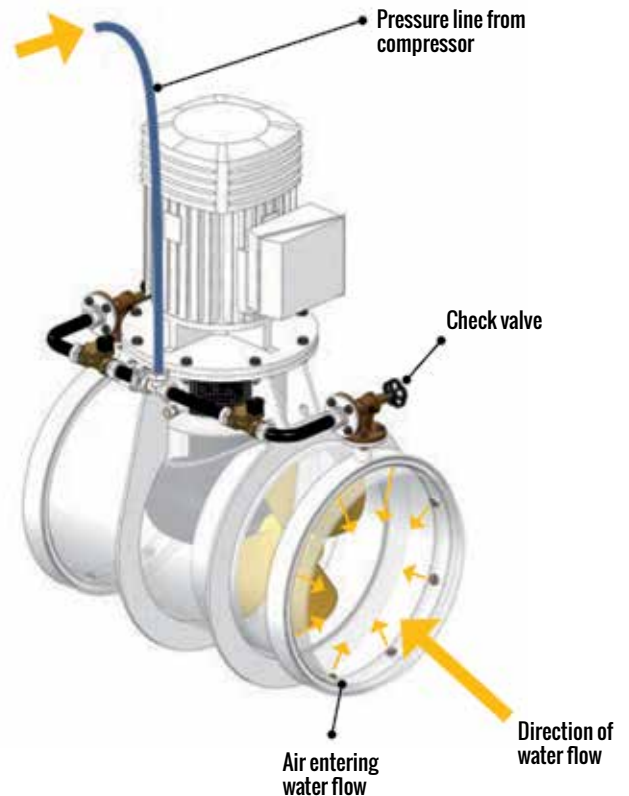

Unit	Nominal Speed (rpm)	Propeller Type	Propeller Diameter (mm)	V <sub>tip</sub> (m/s)	Veth (kW)
VZ-200	1800	Open	Ø900	27	245
		Open	Ø1000	30	245
		Ducted	Ø900	27	245
VZ-320	1800	Open	Ø1100	31	330
		Ducted	Ø1050	29	330
VZ-320A	2100	Open	Ø1100	31	335
		Ducted	Ø1050	29	335
VZ-400A	1800	Open	Ø1100	32	380
		Ducted	Ø1030	30	417
VZ-400	1800	Open	Ø1250	31	470
		Ducted	Ø1130	28	470
VZ-550	1800	Open	Ø1350	31	555
		Ducted	Ø1250	29	555
VZ-700	1800	Open	Ø1500	31	707
		Ducted	Ø1400	29	716
VZ-900	1800	Open	Ø1600	29	804
		Open	Ø1700	31	908
		Ducted	Ø1600	29	968
		Ducted	Ø1700	31	968
VZ-900A	1600	Open	Ø1600	29	804
		Open	Ø1700	31	908
		Ducted	Ø1600	29	945
		Ducted	Ø1700	31	945
VZ-1100	1800	Open	Ø1900	32	1134
		Ducted	Ø1800	30	1272
		Ducted	Ø1900	32	1305
VZ-1100A	1600	Open	Ø1900	32	1134
		Ducted	Ø1800	30	1272
		Ducted	Ø1900	32	1305
VZ-1250	1800	Open	Ø2100	33	1385
		Ducted	Ø1900	30	1418
		Ducted	Ø2000	31	1425
		Ducted	Ø2100	33	1425
VZ-1250A	1600	Open	Ø2100	31	1385
		Ducted	Ø1900	28	1418
		Ducted	Ø2000	30	1425
		Ducted	Ø2100	31	1425
VZ-1250B <sup>1</sup>	1200	Open	Ø2100	29	1385
		Ducted	Ø1900	26	1418
		Ducted	Ø2000	28	1425
		Ducted	Ø2100	29	1425
VZ-1250C <sup>1</sup>	1000	Open	Ø2100	31	1385
		Ducted	Ø1900	28	1418
		Ducted	Ø2000	30	1425
		Ducted	Ø2100	31	1425
VZ-1250D <sup>1</sup>	900	Open	Ø2100	31	1385
		Ducted	Ø1900	28	1418
		Ducted	Ø2000	29	1425
		Ducted	Ø2100	31	1425
VZ-1250F <sup>1</sup>	750	Open	Ø2100	31	1385
		Ducted	Ø1900	28	1418
		Ducted	Ø2000	29	1425
		Ducted	Ø2100	31	1425

LRS (kW)		BV (kW)	ABS (kW)	RINA (kW)	DNV-GL (kW)
Inland	Seagoing				
245	245	233	207	216	165
245	245	233	207	216	165
245	245	233	207	216	165
245	245	233	207	216	165
330	330	319/330*	284/313*	319/330*	207
330	330	319/330*	284/313*	319/330*	207
335	335	319/335*	283/317*	319/335*	209
335	335	319/335*	283/317*	319/335*	209
380	380	380	380	380	333
417	417	417	392/416*	410/417*	370
417	417	468	416/432*	435/469*	345
417	417	468	416/432*	435/469*	345
484	484	555	555	484	420
484	484	555	555	484	420
707	707	688	616/634*	643/688*	480
716	716	688	616/634*	643/688*	480
804	804	804	804	804	800
908	908	908	908	908	800
945	945	968	968	958	800
945	945	968	968	958	800
804	804	804	804	804	790
908	908	876	869	869	790
958	958	876	869	869	790
958	958	876	869	869	790
1134	1134	1134	1118/1143*	1134	1110
1272	1272	1258/1272*	1118/1243*	1168/1272*	1110
1305	1305	1258/1305*	1118/1243*	1168/1305*	1110
1134	1134	1134	1134	1134	1110
1272	1272	1272	1272	1272	1110
1305	1305	1305	1291/1305*	1305	1110
1385	1385	1385	1289/1385*	1346/1385*	1197/1350*
1418	1418	1418	1289/1418*	1346/1418*	1197/1350*
1425	1425	1425	1289/1425*	1346/1425*	1197/1350*
1425	1425	1425	1289/1425*	1346/1425*	1197/1350*
1385	1385	1385	1291/1385*	1348/1385*	1181/1197*
1418	1418	1418	1291/1418*	1348/1418*	1181/1197*
1425	1425	1425	1291/1425*	1348/1425*	1181/1197*
1425	1425	1385	1291/1425*	1348/1425*	1181/1197*
1320	1320	1385	1307/1320*	1320	900
1320	1320	1418	1307/1321*	1320	900
1320	1320	1418	1307/1322*	1320	900
1320	1320	1420	1307/1323*	1320	900
1385	1385	1385	1325/1385*	1384/1385*	1089/1293*
1418	1418	1418	1325/1418*	1384/1418*	1089/1293*
1425	1425	1425	1325/1425*	1384/1425*	1089/1293*
1425	1425	1425	1325/1425*	1384/1425*	1089/1293*
1385	1385	1385	1329/1385*	1385	1038/1231*
1418	1418	1418	1329/1418*	1388/1418*	1038/1231*
1425	1425	1425	1329/1425*	1388/1425*	1038/1231*
1425	1425	1425	1329/1425*	1388/1425*	1038/1231*
1385	1385	1385	1310/1385*	1368/1385*	1075/1275*
1418	1418	1418	1310/1418*	1368/1418*	1075/1275*
1425	1425	1425	1310/1425*	1368/1425*	1075/1275*
1425	1425	1425	1310/1425*	1368/1425*	1075/1275*

Unit	Nominal Speed (rpm)	Propeller Type	Propeller Diameter (mm)	V <sub>tip</sub> (m/s)	Veth (kW)
	Ducted	Ø2200	31	1901	
	Ducted	Ø2300	32	1920	
	Ducted	Ø2400	33	1920	
VZ-1550A	1600	Open	Ø2400	33	1810
		Ducted	Ø2200	30	1901
		Ducted	Ø2300	32	1920
		Ducted	Ø2400	33	1920
VZ-1550C <sup>1</sup>	1000	Open	Ø2400	33	1810
		Ducted	Ø2200	31	1901
		Ducted	Ø2300	32	1920
		Ducted	Ø2400	33	1920
VZ-1550D <sup>1</sup>	900	Open	Ø2400	33	1810
		Ducted	Ø2200	31	1901
		Ducted	Ø2300	32	1920
		Ducted	Ø2400	33	1920
VZ-1550F <sup>1</sup>	750	Open	Ø2400	33	1810
		Ducted	Ø2200	30	1901
		Ducted	Ø2300	31	1920
		Ducted	Ø2400	33	1920
VZ-1800	1800	Open	Ø2600	34	2124
		Ducted	Ø2400	31	2262
		Ducted	Ø2500	32	2350
		Ducted	Ø2600	34	2350
VZ-1800A	1600	Open	Ø2600	33	2124
		Ducted	Ø2400	31	2262
		Ducted	Ø2500	32	2350
		Ducted	Ø2600	33	2350
VZ-1800B	1500	Open	Ø2600	33	2124
		Ducted	Ø2400	31	2262
		Ducted	Ø2500	32	2350
		Ducted	Ø2600	33	2350
VZ-1800D <sup>1</sup>	1200	Open	Ø2600	34	2124
		Ducted	Ø2400	31	2262
		Ducted	Ø2500	33	2350
		Ducted	Ø2600	34	2350
VZ-1800F <sup>1</sup>	1000	Open	Ø2600	33	2124
		Ducted	Ø2400	31	2262
		Ducted	Ø2500	32	2350
		Ducted	Ø2600	33	2350
VZ-1800G <sup>1</sup>	900	Open	Ø2600	33	2124
		Ducted	Ø2400	31	2262
		Ducted	Ø2500	32	2350
		Ducted	Ø2600	33	2350
VZ-1800H <sup>1</sup>	750	Open	Ø2600	33	2124
		Ducted	Ø2400	31	2262
		Ducted	Ø2500	32	2350
		Ducted	Ø2600	33	2350

LRS (kW)		BV (kW)	ABS (kW)	RINA (kW)	DNV-GL (kW)
Inland	Seagoing				
1810	1810	1810	1753/1810*	1830/1810*	1525
1901	1901	1901	1753/1901*	1830/1901*	1525
1920	1920	1920	1753/1920*	1830/1920*	1525
1920	1920	1920	1753/1920*	1830/1920*	1525
1810	1810	1810	1746/1810*	1822/1810*	1460
1901	1901	1901	1746/1901*	1822/1901*	1460
1920	1920	1920	1746/1920*	1822/1920*	1460
1920	1920	1920	1746/1920*	1822/1920*	1460
1810	1810	1810	1737/1810	1814/1810	1271/1351*
1901	1901	1901	1737/1901	1814/1901	1271/1351*
1920	1920	1920	1737/1915	1814/1920	1271/1351*
1920	1920	1920	1737/1915	1814/1920	1271/1351*
1810	1810	1810	1755/1810	1810	1315
1901	1901	1901	1755/1901	1832/1901	1315
1920	1920	1920	1755/1920	1832/1920	1315
1920	1920	1920	1755/1920	1832/1920	1315
1810	1810	1810	1755/1810	1793/1810	1285
1901	1901	1901	1718/1891	1793/1901	1285
1920	1920	1920	1718/1891	1793/1920	1285
1920	1920	1920	1718/1891	1793/1920	1285
2124	2124	2124	2124	2124	1913
2262	2262	2262	2256/2262*	2262	1913
2350	2350	2350	2256/2350*	2350	1913
2350	2350	2350	2256/2350*	2350	1913
2124	2124	2124	2124	2124	1815
2262	2262	2262	2249/2262*	2262	1815
2350	2350	2350	2249/2350*	2347/2350*	1815
2350	2350	2350	2249/2350*	2347/2350*	1815
2124	2124	2124	2124	2124	1815
2262	2262	2262	2240/2262*	2262	1815
2350	2350	2350	2240/2350*	2338/2350*	1815
2350	2350	2350	2240/2350*	2338/2350*	1815
2124	2124	2124	2112/2124*	2124	1540/1830*
2262	2262	2262	2112/2262*	2206/2262*	1540/1830*
2350	2350	2350	2112/2350*	2206/2350*	1540/1830*
2350	2350	2350	2112/2350*	2206/2350*	1540/1830*
2124	2124	2124	2124	2124	1743/2000*
2262	2262	2262	2244/2262*	2262	1743/2000*
2350	2350	2350	2244/2350*	2343/2350*	1743/2000*
2350	2350	2350	2244/2350*	2343/2350*	1743/2000*
2124	2124	2124	2124	2124	1706/2000*
2262	2262	2262	2223/2262*	2262	1706/2000*
2350	2350	2350	2223/2350*	2320/2350*	1706/2000*
2350	2350	2350	2223/2350*	2320/2350*	1706/2000*
2124	2124	2124	2124	2124	1953/2000*
2262	2262	2262	2244/2262*	2262	1953/2000*
2350	2350	2350	2244/2350*	2343/2350*	1953/2000*
2350	2350	2350	2244/2350*	2343/2350*	1953/2000*

<sup>1</sup> Concept design only; delivery time on request.

\* Number applies when the upper and/or lower gears are shotpeened.

Ratings are in kilowatts (kW) and are based on both maximum blade load (400 kW/m<sup>2</sup> for open propeller and 500 kW/m<sup>2</sup> for ducted propellers) and maximum machinery power.

Unit	Nominal Speed (rpm)	Propeller Diameter (mm)		V <sub>tip</sub> (m/s)	Veth (kW)
		Front	Aft		
VZ-160-CR	1800	Ø650	Ø585	28	155
VZ-250-CR	1800	Ø850	Ø765	27	325
VZ-250A-CR	2100	Ø850	Ø765	28	329
VZ-450-CR	1800	Ø1100	Ø990	25	475
		Ø1200	Ø1080	27	475
VZ-700-CR	1800	Ø1350	Ø1215	25	737
VZ-900-CR	1800	Ø1400	Ø1260	25	975
		Ø1450	Ø1305	26	995
		Ø1500	Ø1350	27	995
VZ-900A-CR	1600	Ø1400	Ø1260	25	938
		Ø1450	Ø1305	25	938
		Ø1500	Ø1350	26	938
VZ-1250-CR	1800	Ø1650	Ø1485	28	1355
		Ø1700	Ø1530	29	1425
VZ-1250A-CR	1600	Ø1650	Ø1485	30	1355
		Ø1700	Ø1530	31	1425
VZ-1550-CR	1800	Ø1900	Ø1710	28	1800
		Ø2000	Ø1800	30	1920

\* Number applies when the upper and/or lower gears are shotpeened.  
 Ratings are in kilowatts (kW) and are based on both maximum blade load (350 kW/m<sup>2</sup> for contra-rotating propellers, 400 kW/m<sup>2</sup> for open propellers and 500 kW/m<sup>2</sup> for ducted propellers) and maximum machinery power.

LRS (kW)		BV (kW)	ABS (kW)	RINA (kW)	DNV-GL (kW)
Inland	Seagoing				
on request	on request	on request	on request	on request	on request
341	285	312	279/288*	292/312*	174
350	289	317	383/292*	383/317*	176
435	435	441/475*	392/432*	410/435*	325
435	435	441/475*	392/432*	410/435*	325
694	694	677	611	637	632
958	958	975	933	958	845
958	958	985	933	958	845
958	958	985	933	958	845
869	869	876	869	869	765
869	869	876	869	869	765
869	869	876	869	869	765
869	869	876	869	869	765
1355	1355	1355	1256/1355*	1311/1355*	1304
1395	1395	1390	1256/1383*	1311/1390*	1304
1355	1355	1355	1355	1355	1328/1355*
1425	1425	1425	1377/1425*	1425	1425
1800	1800	1800	1735/1800*	1800	1581
1920	1920	1920	1735/1910*	1811/1920*	1581

# MAIN PROPULSION RATINGS ELECTRIC-DRIVEN Z-DRIVES



Unit	Nominal Speed (rpm)	Propeller Type	Propeller Diameter (mm)	V <sub>tip</sub> (m/s)	Veth (kW)	LRS (kW)		BV (kW)	ABS (kW)	RINA (kW)	DNV-GL (kW)
						Inland	Seagoing				
VZ-200	1800	Open	Ø900	27	254	254	248	254	245	254	165
		Open	Ø1000	30	265	265	248	260	245	260	165
		Ducted	Ø900	27	265	265	28	260	245	260	165
VZ-320	1800	Open	Ø1100	31	330	330	330	330	330	330	235
		Ducted	Ø1050	29	330	330	330	330	330	330	235
VZ-400A	1800	Open	Ø1100	32	470	470	470	470	470	470	370
		Ducted	Ø1030	30	470	470	470	470	470	470	370
VZ-400	1800	Open	Ø1250	31	380	380	380	380	380	380	345
		Ducted	Ø1130	28	417	417	417	417	417	417	345
VZ-550	1800	Open	Ø1350	31	555	555	555	555	555	555	420
		Ducted	Ø1250	29	555	555	555	555	555	555	420
VZ-700	1800	Open	Ø1500	31	707	707	707	707	707	707	480
		Ducted	Ø1400	29	770	770	738	770	735	770	480
VZ-900	1800	Open	Ø1600	29	804	804	804	804	804	804	800
		Open	Ø1700	31	908	908	908	908	908	908	800
		Ducted	Ø1600	29	968	968	968	968	968	968	800
		Ducted	Ø1700	31	968	968	968	968	968	968	800
VZ-900A	1600	Open	Ø1600	29	804	804	804	804	804	804	790
		Open	Ø1700	31	908	908	908	869	908	908	790
		Ducted	Ø1600	29	945	945	945	869	945	945	790
		Ducted	Ø1700	31	945	945	945	869	945	945	790
VZ-1100	1800	Open	Ø1900	32	1134	1134	1134	1134	1118/1143*	1134	1110
		Ducted	Ø1800	30	1272	1272	1272	1272	1272	1272	1110
		Ducted	Ø1900	32	1305	1305	1305	1305	1305	1305	1110
VZ-1100A	1600	Open	Ø1900	32	1134	1134	1134	1134	1134	1134	1110
		Ducted	Ø1800	30	1272	1272	1272	1272	1272	1272	1110
		Ducted	Ø1900	32	1305	1305	1305	1305	1305	1305	1110
VZ-1250	1800	Open	Ø2100	33	1385	1385	1385	1385	1385	1385	1375
		Ducted	Ø1900	30	1418	1418	1418	1418	1418	1418	1375
		Ducted	Ø2000	31	1425	1425	1425	1425	1425	1425	1375
		Ducted	Ø2100	33	1425	1425	1425	1425	1425	1425	1375
VZ-1250A	1600	Open	Ø2100	31	1385	1385	1385	1385	1385	1385	1186/1220*
		Ducted	Ø1900	28	1418	1418	1418	1418	1418	1418	1186/1220*
		Ducted	Ø2000	30	1425	1425	1425	1425	1425	1425	1186/1220*
		Ducted	Ø2100	31	1425	1425	1425	1425	1425	1425	1186/1220*
VZ-1550	1800	Open	Ø2400	33	1810	1810	1810	1810	1810	1810	1661
		Ducted	Ø2200	31	1901	1901	1901	1901	1901	1901	1661
		Ducted	Ø2300	32	1920	1920	1920	1920	1920	1920	1661
		Ducted	Ø2400	33	1920	1920	1920	1920	1920	1920	1661
VZ-1550A	1600	Open	Ø2400	33	1810	1810	1810	1810	1810	1810	1500
		Ducted	Ø2200	30	1901	1901	1901	1901	1901	1901	1500
		Ducted	Ø2300	32	1920	1920	1920	1920	1920	1920	1500
		Ducted	Ø2400	33	1920	1920	1920	1920	1920	1920	1500

\* Number applies when the upper and/or lower gears are shotpeened.  
 Ratings are in kilowatts (kW) and are based on both maximum blade load (400 kW/m<sup>2</sup> for open propeller and 500 kW/m<sup>2</sup> for ducted propellers) and maximum machinery power.

# MAIN PROPULSION RATINGS ELECTRIC-DRIVEN Z-DRIVES



Unit	Nominal Speed (rpm)	Propeller Type	Propeller Diameter (mm)	V <sub>tip</sub> (m/s)	Veth (kW)
VZ-1800	1800	Open	Ø2600	34	2124
		Ducted	Ø2400	31	2262
		Ducted	Ø2500	32	2350
		Ducted	Ø2600	34	2350
VZ-1800A	1600	Open	Ø2600	33	2124
		Ducted	Ø2400	31	2262
		Ducted	Ø2500	32	2350
		Ducted	Ø2600	33	2350
VZ-1800B	1500	Open	Ø2600	33	2124
		Ducted	Ø2400	31	2262
		Ducted	Ø2500	32	2350
		Ducted	Ø2600	33	2350

LRS (kW)		BV (kW)	ABS (kW)	RINA (kW)	DNV-GL (kW)
Inland	Seagoing				
2124	2124	2124	2124	2124	2000
2262	2262	2262	2262	2262	2000
2350	2350	2350	2350	2350	2000
2350	2350	2350	2350	2350	2000
2124	2124	2124	2124	2124	1815
2262	2262	2262	2262	2262	1815
2350	2350	2350	2350	2350	1815
2350	2350	2350	2350	2350	1815
2124	2124	2124	2124	2124	1815
2262	2262	2262	2262	2262	1815
2350	2350	2350	2350	2350	1815
2350	2350	2350	2350	2350	1815

Ratings are in kilowatts (kW) and are based on both maximum blade load (400 kW/m<sup>2</sup> for open propeller and 500 kW/m<sup>2</sup> for ducted propellers) and maximum machinery power.

# MAIN PROPULSION RATINGS ELECTRIC-DRIVEN Z-DRIVES (CR)



Unit	Nominal Speed (rpm)	Propeller Diameter (mm)		V <sub>tip</sub> (m/s)	Veth (kW)
		Front	Aft		
VZ-160-CR	1800	Ø650	Ø585	28	155
VZ-250-CR	1800	Ø850	Ø765	27	345
VZ-450-CR	1800	Ø1100	Ø990	25	480
		Ø1200	Ø1080	27	480
VZ-700-CR	1800	Ø1350	Ø1215	25	834
VZ-900-CR	1800	Ø1400	Ø1260	25	975
		Ø1450	Ø1305	26	995
		Ø1500	Ø1350	27	995
VZ-900A-CR	1600	Ø1400	Ø1260	25	938
		Ø1450	Ø1305	25	938
		Ø1500	Ø1350	26	938
VZ-1250-CR	1800	Ø1650	Ø1485	28	1355
		Ø1700	Ø1530	29	1425
VZ-1250A-CR	1600	Ø1650	Ø1485	30	1355
		Ø1700	Ø1530	31	1425
VZ-1550-CR	1800	Ø1900	Ø1710	28	1800
		Ø2000	Ø1800	30	1920

Ratings are in kilowatts (kW) and are based on both maximum blade load (350 kW/m<sup>2</sup> for contra-rotating propellers) and maximum machinery power.

LRS (kW)		BV (kW)	ABS (kW)	RINA (kW)	DNV-GL (kW)
Inland	Seagoing				
On request	On request	On request	On request	On request	On request
345	336	345	345	345	205
475	475	475	475	475	325
475	475	475	475	475	325
802	802	783	783	783	747
975	975	975	975	975	845
995	995	995	978	995	845
995	995	995	978	995	845
938	938	938	869	938	765
938	938	938	869	938	765
938	938	938	869	938	765
1355	1355	1355	1355	1355	1293
1425	1425	1425	1425	1425	1293
1355	1355	1355	1355	1355	1355
1425	1425	1425	1425	1425	1425
1800	1800	1800	1800	1800	1800
1920	1920	1920	1920	1920	1869

Unit	Nominal Speed (rpm)	Propeller Type	Propeller Diameter (mm)	V <sub>tip</sub> (m/s)	Veth (kW)
VL-50	1800	Open	Ø450	29	61
		Ducted	Ø450	29	61
VL-90	1800	Open	Ø600	30	115
		Open	Ø650	33	135
		Ducted	Ø600	30	140
VL-180	1500	Open	Ø800		168
		Open	Ø700	29	154
	1800	Ducted	Ø700	29	192
VL-200	1500	Open	Ø900	38	254
		Open	Ø1000	43	265
		Ducted	Ø900	27	265
VL-320	1500	Open	Ø1100	31	370
		Ducted	Ø1050	30	370
VL-400A	1200	Open	Ø1100	33	380
		Ducted	Ø1030	31	417
VL-400	1500	Open	Ø1250	34	491
		Ducted	Ø1130	30	500
VL-550	900	Open	Ø1350	29	533
		Ducted	Ø1250	27	533
VL-550	1000	Open	Ø1350	32	555
		Ducted	Ø1250	30	555
VL-550	1500	Open	Ø1350	30	517
		Ducted	Ø1250	28	517
VL-700	1000	Open	Ø1500	32	707
		Ducted	Ø1400	30	760
VL-700	1500	Open	Ø1500	33	650
		Ducted	Ø1400	31	650
VL-900	900	Open	Ø1600	32	804
		Open	Ø1700	34	908
		Ducted	Ø1600	32	968
		Ducted	Ø1700	34	968
VL-1100	900	Open	Ø1900	33	1134
		Ducted	Ø1800	31	1272
		Ducted	Ø1900	33	1305
VL-1250	900	Open	Ø2100	32	1385
		Ducted	Ø1900	29	1418
		Ducted	Ø2000	31	1425
		Ducted	Ø2100	32	1425
VL-1550	750	Open	Ø2400	34	1810
		Ducted	Ø2200	31	1901
		Ducted	Ø2300	32	1920
		Ducted	Ø2400	34	1920
VL-1800	750	Open	Ø2600	32	2124
		Ducted	Ø2400	30	2262
		Ducted	Ø2500	31	2306
		Ducted	Ø2600	32	2306

LRS (kW)		BV (kW)	ABS (kW)	RINA (kW)	DNV-GL (kW)
Inland	Seagoing				
61	61	57	57	57	36
61	61	57	57	57	36
115	115	115	115	115	97/102*
135	135	135	133	139	97/102*
140	140	140	133/140*	139	97/102*
168	152	168	168	168	114
154	154	154	154	154	137
192	183	192	192	192	137
254	250	254	254	254	178
265	250	265	265	265	178
265	250	265	265	265	178
370	370	370	370	370	186
370	370	370	370	370	186
380	380	380	380	380	380
417	417	417	417	417	417
491	491	491	491	491	367
500	500	500	500	500	367
533	533	533	533	533	398
533	533	533	533	533	398
555	555	555	555	555	442
555	555	555	555	555	442
540	429	517	517	496	369
540	429	517	517	496	369
707	707	707	707	707	490
770	762	760	760	760	490
681	542	650	628	682	495
681	542	650	628	682	495
804	804	804	804	804	804
908	908	908	908	908	865
968	968	968	968	968	865
968	968	968	968	968	865
1134	1134	1134	1134	1134	1134
1272	1272	1272	1272	1272	1140
1305	1305	1305	1305	1305	1140
1385	1385	1385	1385	1385	1355
1418	1418	1418	1418	1418	1355
1425	1425	1425	1425	1425	1355
1425	1425	1425	1425	1425	1355
1810	1810	1810	1810	1810	1810
1901	1901	1901	1901	1901	1831
1920	1920	1920	1920	1920	1831
1920	1920	1920	1920	1920	1831
2124	2124	2124	2124	2124	2030
2262	2262	2262	2262	2262	2030
2306	2306	2306	2306	2306	2030
2306	2306	2306	2306	2306	2030

\* Number applies when the upper and/or lower gears are shotpeened. Ratings are in kilowatts (kW) and are based on both maximum blade load (400 kW/m<sup>2</sup> for open propeller and 500 kW/m<sup>2</sup> for ducted propellers) and maximum machinery power.



Unit	Nominal Speed (rpm)	Propeller Diameter (mm)		V <sub>tip</sub> (m/s)	Veth (kW)
		Front	Aft		
VL-160-CR	1500	Ø650	Ø585	28	183
VL-250-CR	1500	Ø850	Ø765	27	350
VL-450-CR	1200	Ø1100	Ø990	25	500
		Ø1200	Ø1080	27	500
VL-700-CR	900	Ø1350	Ø1210	28	850
VL-900-CR	900	Ø1400	Ø1260	27	975
		Ø1450	Ø1305	28	1000
		Ø1500	Ø1350	29	1000
VL-1250-CR	1000	Ø1650	Ø1485	28	1355
		Ø1700	Ø1530	29	1425
VL-1550-CR	750	Ø1900	Ø1710	29	1800
		Ø2000	Ø1800	30	1920

Ratings are in kilowatts (kW) and are based on both maximum blade load (350 kW/m<sup>2</sup> for contra-rotating propellers) and maximum machinery power.

LRS (kW)		BV (kW)	ABS (kW)	RINA (kW)	DNV-GL (kW)
Inland	Seagoing				
On request	On request	On request	On request	On request	On request
350	339	350	347	350	164
500	500	500	500	500	500
500	500	500	500	500	500
850	850	850	850	850	811
975	975	975	975	975	975
1000	1000	1000	1000	1000	1000
1000	1000	1000	1000	1000	1000
1355	1355	1355	1355	1355	1311
1425	1425	1425	1425	1425	1311
1800	1800	1800	1800	1800	1800
1920	1920	1920	1920	1920	1898

# MAIN PROPULSION RATINGS L-DRIVES: (SEMI) INTEGRATED



Unit	Nominal Speed (rpm)	Propeller Type	Propeller Diameter (mm)	V <sub>tip</sub> (m/s)	Veth (kW)
VL-90si	1500	Open	Ø600	30	113
		Open	Ø650	33	133
		Nozzled	Ø600	30	140
VL-180si	1500	Open	Ø700	24	154
		Open	Ø800	24	168
		Ducted	Ø700	27	168
	1800	Open	Ø700	29	154
		Open	Ø800	33	201
		Ducted	Ø700	29	192
VL-200si	1500	Open	Ø900	27	254
		Open	Ø1000	31	265
		Ducted	Ø900	27	265
VL-320si	1500	Open	Ø1100	31	370
		Ducted	Ø1050	30	370
VL-400si	1500	Open	Ø1250	34	491
		Ducted	Ø1130	30	500
VL-550si	900	Open	Ø1250	27	491
	1000	Ducted	Ø1130	27	501
VL-550i	900	Open	Ø1350	29	533
		Ducted	Ø1250	27	533
VL-700i	1000	Open	Ø1500	32	707
		Ducted	Ø1400	30	760
VL-900i	900	Open	Ø1600	32	804
		Open	Ø1700	34	908
		Ducted	Ø1600	32	968
		Ducted	Ø1700	34	968
VL-1100i	900	Open	Ø1900	33	1134
		Ducted	Ø1800	31	1272
		Ducted	Ø1900	33	1305
VL-1250i	900	Open	Ø2100	32	1385
		Ducted	Ø1900	29	1418
		Ducted	Ø2000	31	1425
		Ducted	Ø2100	32	1425
VL-1550i	750	Open	Ø2400	34	1810
		Ducted	Ø2200	31	1901
		Ducted	Ø2300	32	1920
		Ducted	Ø2400	34	1920
VL-1800i	750	Open	Ø2600	32	2124
		Ducted	Ø2400	30	2262
		Ducted	Ø2500	31	2306
		Ducted	Ø2600	32	2306

LRS (kW)		BV (kW)	ABS (kW)	RINA (kW)	DNV-GL (kW)
Inland	Seagoing				
113	113	113	113	113	102
133	133	133	133	133	102
140	140	140	133	139	102
154	152	154	154	154	114
168	152	168	168	168	114
168	152	168	168	168	114
154	152	154	154	154	114
201	183	201	201	201	137
192	183	192	192	192	137
254	250	254	254	254	178
265	250	265	265	265	178
265	250	265	265	265	178
370	370	370	370	370	246
370	370	370	370	370	246
491	491	491	491	491	375
500	500	500	500	500	375
491	491	491	491	491	398
501	501	501	501	501	442
533	533	533	533	533	398
533	533	533	533	533	398
707	707	707	707	707	490
760	760	760	760	760	490
804	804	804	804	804	804
908	908	908	908	908	865
968	968	968	968	968	865
968	968	968	968	968	865
1134	1134	1134	1134	1134	1134
1272	1272	1272	1272	1272	1140
1305	1305	1305	1305	1305	1140
1385	1385	1385	1385	1385	1355
1418	1418	1418	1418	1418	1355
1425	1425	1425	1425	1425	1355
1425	1425	1425	1425	1425	1355
1810	1810	1810	1810	1810	1810
1901	1901	1901	1901	1901	1831
1920	1920	1920	1920	1920	1831
1920	1920	1920	1920	1920	1831
2124	2124	2124	2124	2124	2030
2262	2262	2262	2262	2262	2030
2306	2306	2306	2306	2306	2030
2306	2306	2306	2306	2306	2030

Ratings are in kilowatts (kW) and are based on both maximum blade load (400 kW/m<sup>2</sup> for open propeller and 500 kW/m<sup>2</sup> for ducted propellers) and maximum machinery power.

# MAIN PROPULSION RATINGS L-DRIVES: (SEMI) INTEGRATED (CR)



Unit	Nominal Speed (rpm)	Propeller Diameter (mm)		V <sub>tip</sub> (m/s)	Veth (kW)
		Front	Aft		
VL-160si-CR	1500	Ø650	Ø585	28	166
VL-250si-CR	1500	Ø850	Ø765	27	350
VL-450si-CR	1200	Ø1100	Ø990	25	500
		Ø1200	Ø1080	27	500
VL-700i-CR	900	Ø1350	Ø1210	28	600
VL-720i-CR	900	Ø1350	Ø1210	28	850
VL-900i-CR	900	Ø1400	Ø1260	27	975
		Ø1450	Ø1305	28	1000
		Ø1500	Ø1350	29	1000
VL-1250i-CR	1000	Ø1650	Ø1450	28	1355
		Ø1700	Ø1530	29	1425
VL-1550i-CR	750	Ø1900	Ø1710	29	1800
		Ø2000	Ø1800	30	2000

Ratings are in kilowatts (kW) and are based on both maximum blade load (350 kW/m<sup>2</sup> for contra-rotating propellers) and maximum machinery power.

LRS (kW)		BV (kW)	ABS (kW)	RINA (kW)	DNV-GL (kW)
Inland	Seagoing				
166	152	166	160	174	134
350	339	350	347	350	207
500	500	500	500	500	500
500	500	500	500	500	500
600	600	600	600	600	600
850	850	850	850	850	811
975	975	975	975	975	975
1000	1000	1000	1000	1000	1000
1000	1000	1000	1000	1000	1000
1355	1355	1355	1355	1355	1311
1425	1425	1425	1425	1425	1311
1800	1800	1800	1800	1800	1800
2000	2000	2000	2000	2000	1898

## AUXILIARY POWER UNIT RATINGS DIESEL-DRIVEN VETH JET

Unit	Nominal Speed (rpm)	Propeller Diameter (mm)	V <sub>tip</sub> (m/s)	Veth (kW)
K-800	1800	Ø780	24	191
K-1000	1800	Ø980	30	283
K-1000NR	2100	Ø980	32	280
K-1200	1800	Ø1180	28	404
K-1300	1800	Ø1280	30	478
K-1300A	2100	Ø1280	30	577
K-1400	1800	Ø1420	27	618
K-1400A	1800	Ø1420	30	550
K-1400NR	1500	Ø1420	28	618
K-1650 <sup>1</sup>	1800	Ø1650	31	956
K-1800	1800	Ø1800	30	1257

LRS (kW)		BV (kW)	ABS (kW)	RINA (kW)	DNV-GL (kW)
Inland	Seagoing				
191	191	191	191	191	191
283	283	283	283	283	283
280	280	225	280	280	280
404	404	235	404	404	300
478	478	437	478	478	300
577	577	559	577	500	288
618	618	618	618	500	510
550	550	532	550	550	373
618	618	618	618	500	437
956	956	956	956	956	763
1257	1257	1257	1257	1257	1000

## AUXILIARY POWER UNIT RATINGS ELECTRIC-DRIVEN VETH JET

Unit	Nominal Speed (rpm)	Propeller Diameter (mm)	V <sub>tip</sub> (m/s)	Veth (kW)
K-800	1800	Ø780	24	191
K-800V	1800	Ø780	24	191
K-1000	1800	Ø980	30	283
K-1000NR	2100	Ø980	32	280
K-1000V	1800	Ø980	30	283
K-1200	1800	Ø1180	28	404
K-1200V	1800	Ø1180	28	404
K-1300	1800	Ø1280	30	478
K-1300V	1800	Ø1280	30	487
K-1300A	2100	Ø1280	30	577
K-1400	1800	Ø1420	27	618
K-1400A	1800	Ø1420	30	550
K-1400NR	1500	Ø1420	28	618
K-1650 <sup>1</sup>	1800	Ø1650	31	1062
K-1800	1800	Ø1800	30	1257

LRS (kW)		BV (kW)	ABS (kW)	RINA (kW)	DNV-GL (kW)
Inland	Seagoing				
191	191	191	191	191	191
191	191	191	191	191	191
283	283	283	283	283	283
280	280	225	280	280	280
283	283	283	283	283	283
404	404	372	404	404	300
404	404	404	404	404	300
478	478	478	478	478	348
487	487	487	487	487	300
577	577	577	577	500	450
618	618	618	618	500	510
550	550	550	550	500	441
618	618	618	618	500	510
1062	1062	1062	1062	1062	900
1257	1257	1257	1257	1257	1000

<sup>1</sup> Concept design only; delivery time on request.  
Ratings are in kilowatts (kW) and are based on both maximum blade load (500 kW/m<sup>2</sup>) and maximum machinery power.

## AUXILIARY POWER UNIT RATINGS DIESEL-DRIVEN COMPACT JET (CJ)

Unit	Nominal Speed (rpm)	Propeller Diameter (mm)	V <sub>tip</sub> (m/s)	Veth (kW)
CJ-800	1800	Ø840	27	225
	2000	Ø840	30	225
CJ-1000	1800	Ø1040	27	340
	2000	Ø1040	31	340
CJ-1200	1800	Ø1240	30	483
	2000	Ø1240	33	483
CJ-1400 <sup>1</sup>	1800	Ø1400	29	616

LRS (kW)		BV (kW)	ABS (kW)	RINA (kW)	DNV-GL (kW)
Inland	Seagoing				
225	225	225	225	225	225
225	225	225	225	225	225
330	330	340	340	340	300
340	340	340	340	340	300
483	483	483	483	483	300
483	483	483	483	483	300
616	616	600	616	600	471

## AUXILIARY POWER UNIT RATINGS ELECTRIC-DRIVEN COMPACT JET (CJ)

Unit	Nominal Speed (rpm)	Propeller Diameter (mm)	V <sub>tip</sub> (m/s)	Veth (kW)
CJ-800	1800	Ø840	28	225
	2000	Ø840	30	225
CJ-800V	1800	Ø840	30	225
CJ-1000	1800	Ø1040	27	340
	2000	Ø1040	31	340
CJ-1000V	1800	Ø1040	28	340
CJ-1200	1800	Ø1240	30	483
	2000	Ø1240	33	483
CJ-1200V	1000	Ø1240	31	483
CJ-1400	1800	Ø1400	29	616
CJ-1400V	1000	Ø1400	30	616

LRS (kW)		BV (kW)	ABS (kW)	RINA (kW)	DNV-GL (kW)
Inland	Seagoing				
225	225	225	225	225	225
225	225	225	225	225	225
225	225	225	225	225	225
340	340	340	340	340	300
340	340	340	340	340	300
483	483	450	483	483	300
483	483	450	483	483	300
483	483	483	483	483	300
483	483	450	483	483	300
616	616	600	616	600	557
616	616	616	616	616	574

## AUXILIARY POWER UNIT RATINGS VETH COMPACT GRID (VCG)

Unit	Nominal Speed (rpm)	Propeller Diameter (mm)	V <sub>tip</sub> (m/s)	Veth (kW)
VCG-400	1500	Ø400	31	50
VCG-600	1000	Ø580	30	99
VCG-750	750	Ø750	29	177

LRS (kW)		BV (kW)	ABS (kW)	RINA (kW)	DNV-GL (kW)
Inland	Seagoing				
50	50	50	50	50	50
99	99	99	99	99	99
177	177	177	177	177	177

<sup>1</sup> Concept design only; delivery time on request.  
Ratings are in kilowatts (kW) and are based on both maximum blade load (500 kW/m<sup>2</sup>) and maximum machinery power.

# AUXILIARY POWER UNIT RATINGS

DIESEL-DRIVEN  
STEERING GRID



Unit	Nominal Speed (rpm)	Propeller Diameter (mm)	V <sub>tip</sub> (m/s)	Veth (kW)
VSG-800	1800	Ø780	24	191
VSG-1000(L)	1800	Ø980	30	283
VSG-1200(L)	1800	Ø1180	28	404
VSG-1300(L)	1800	Ø1280	30	478
VSG-1300A	2100	Ø1280	30	577
VSG-1400	1800	Ø1420	30	550

Ratings are in kilowatts (kW) and are based on both maximum blade load (500 kW/m<sup>2</sup>) and maximum machinery power.

LRS (kW)		BV (kW)	ABS (kW)	RINA (kW)	DNV-GL (kW)
Inland	Seagoing				
191	191	191	191	191	191
283	283	283	283	283	283
404	404	235	404	404	300
478	478	437	478	478	300
577	577	559	577	500	388
550	550	532	550	500	373

# AUXILIARY POWER UNIT RATINGS

ELECTRIC-DRIVEN  
STEERING GRID

Unit	Nominal Speed (rpm)	Propeller Diameter (mm)	V <sub>tip</sub> (m/s)	Veth (kW)
VSG-800	1800	Ø780	24	191
VSG-1000(L)	1800	Ø980	30	283
VSG-1000V	1800	Ø980	30	283
VSG-1200(L)	1800	Ø1180	28	404
VSG-1200V	1800	Ø1180	28	404
VSG-1300(L)	1800	Ø1280	30	478
VSG-1300V	1800	Ø1280	30	487
VSG-1300A	2100	Ø1280	30	577
VSG-1400	1800	Ø1420	30	550

Ratings are in kilowatts (kW) and are based on both maximum blade load (500 kW/m<sup>2</sup>) and maximum machinery power.

LRS (kW)		BV (kW)	ABS (kW)	RINA (kW)	DNV-GL (kW)
Inland	Seagoing				
191	191	191	191	191	191
283	283	283	283	283	283
283	283	283	283	283	283
404	404	372	404	404	300
404	404	404	404	404	300
478	478	478	478	478	348
487	487	487	487	487	300
577	577	577	577	500	450
550	550	550	550	500	441

# AUXILIARY POWER UNIT RATINGS

TUNNEL THRUSTERS

Unit	Nominal Speed (rpm)	Propeller Diameter (mm)	V <sub>tip</sub> (m/s)	Veth (kW)
VT-50	1800	Ø450	29	64
VT-90	1800	Ø600	30	115
		Ø650	33	135
VT-180	1500	Ø850	29	135
	1800	Ø800	33	202
VT-240	1500	Ø980	30	267
VT-320	1500	Ø1050	30	350
VT-400	1500	Ø1200	32	452
VT-550	1500	Ø1350	30	545
VT-700	1000	Ø1500	32	707
VT-700	1500	Ø1500	33	707
VT-900	750	Ø1800	30	966
VT-900	1500	Ø1600	29	804
		Ø1700	31	908
VT-1250	900	Ø2100	32	1385

\* Number applies when the upper and/or lower gears are shotpeened.  
Ratings are in kilowatts (kW) and are based on both maximum blade load (400 kW/m<sup>2</sup>) and maximum machinery power.

LRS (kW)		BV (kW)	ABS (kW)	RINA (kW)	DNV-GL (kW)
Inland	Seagoing				
64	64	64	64	64	64
115	115	115	115	113	113
135	135	135	135	130	133
168	168	168	168	168	168
202	202	202	202	202	202
267	267	267	267	267	267
350	350	350	350	350	300
452	452	452	452	452	452
545	545	545	545	545	440
707	707	707	707	707	624
707	707	707	707	707	543
966	966	966	966	966	966
804	804	804	804	804	804
908	908	908	908	908	876
1385	1385	1385	1385	1385	1385

## GLOBAL SERVICE

The Twin Disc Global Customer Support Program is committed to providing world-class support in the most efficient and consistent manner for all of our customers. Our regional sales offices and vast distribution network support Twin Disc products all over the world. With a corporate presence in every major market region, and our extensive and growing worldwide network of more than 157 distributor sales and service locations in 86 countries, you can rest assured you're never far from Twin Disc support.

Our program offers a wide range of services from the sales process through commissioning and eventually, upgrade. Twin Disc experts are always available, wherever you are, to help you obtain the best possible return on your investment in our products.



- Twin Disc
- Veth Propulsion
- HQ/Subsidiaries

For a current list of our global dealer network, please check [twindisc.com/vethpropulsion.com](http://twindisc.com/vethpropulsion.com).



Training curriculum provided by the Twin Disc Global Customer Support Program is developed utilizing the latest information and is built upon decades of expertise. Group training in a classroom setting as well as hands-on training with electrical, mechanical and spin test stands provide the most in-depth training for all of our global technicians.

With our vast network of distributor and dealer locations around the world, Twin Disc offers you unprecedented service support. We can put engineering and service expertise on location virtually anywhere. We'll work with you on your particular application and product to ensure optimum results. We're more than just a name you know, Twin Disc is a name you can trust.

Wherever you are when you need support, simply call your local Twin Disc distributor. To find your nearest distributor, go to [www.twindisc.com](http://www.twindisc.com).



## TWIN DISC, INCORPORATED

1328 Racine Street  
Racine, Wisconsin 53403 USA  
Telephone: +1 (262) 638-4000  
Email: sales@twindisc.com

## TWIN DISC INTERNATIONAL SPRL

Chaussé de Namur, 54  
B-1400 Nivelles  
Belgium

## TWIN DISC EUROPEAN DISTRIBUTION SPRL

Chaussé de Namur, 54  
B-1400 Nivelles  
Belgium  
Telephone: +32 (0) 67 887 211  
Email: tdbelgium@twindisc.com

## TWIN DISC SRL

Via S. Cristoforo 131  
40017 S. Matteo Della Decima (BO)  
Italy  
Telephone: +39 051 6819711  
Email: info.technodrive@twindisc.com

## TWIN DISC SRL

Via E.e P. Salani 1  
50050 Limite Sull'Arno (FI)  
Italy  
Telephone: +39 0571 979111  
Email: info.bcs@twindisc.com

## TWIN DISC, INC.

Latin America Office  
231 Lawrence Street  
Marietta, GA 30060  
United States of America  
Telephone: +1-262-902-5297  
Email: becerra.elias@twindisc.com

## TWIN DISC (PACIFIC) PTY. LTD.

40 Telford Street  
Virginia QLD 4014  
Australia  
Telephone: +61 (7) 3265-1200  
Cell: +61 (7) 3865-1371  
Email: twindisc.brisbane@twindisc.com.au

## TWIN DISC (FAR EAST) PTE. LTD.

6, Tuas Avenue 1  
Singapore 639491  
Telephone: (65) 6267 0800  
Email: tan.desmond@twindisc.com

## TWIN DISC POWER TRANSMISSION (SHANGHAI) CO. LTD.

Shanghai Representative Office  
Room 2308, No. 88 South Zun Yi Road  
Chang Ning District  
China 200336  
Telephone: +86 (21) 6427 3212  
+86 (21) 6209 7626  
Email: enquiry@twindisc.com.cn

## TWIN DISC POWER TRANSMISSION PRIVATE, LTD.

EL Heights, 1st Floor  
3 CMM Street  
Nungambakkam, Chennai, 600034  
India  
Telephone: +91 (44) 2821 3099

## ROLLA SP PROPELLERS SA

Via Roncaglia 6  
P.O. Box 109  
Novazzano, 6883  
Switzerland  
Telephone: + 41 (0) 91 695 2000  
Email: info@rolla-propellers.ch

## TWIN DISC JAPAN

Twin Disc Nico Co. Ltd.  
405-3, Yoshinocho 1-chome, Kita-ku  
Saitama-shi, Saitama-ken, 331-0811  
Japan  
Telephone: +81 (48) 652-8069  
Email: info@tdnico.com

## VETH PROPULSION

Nanengat 17  
3356 AA Papendrecht  
The Netherlands  
Telephone: +3178 615 22 66  
Email: info@veth.net

## TWIN DISC, INCORPORATED

Manufacturing Facility  
Lufkin, Texas 75901  
United States of America  
Email: sales@twindisc.com



TWIN DISC  
FAMILY OF  
PRODUCTS



USA • AUSTRALIA • BELGIUM • CHINA • INDIA • ITALY  
NETHERLANDS • SINGAPORE • SWITZERLAND