

MMR-20-BE

MediaMaster® Wired Remote Controller

Product Description

The MMR-20-BE is a water-resistant (IP67 rated), wired remote controller designed to add auxiliary control functionality to MediaMaster® source units. Depending on your system layout, you may add up to three MMR-20-BE remote controllers to a single source unit. Each MMR-20-BE can be connected up to 75 ft. (22.8 m) away from its source unit. A Y-splitter and remote extension cables are sold separately and available in different lengths to suit different mounting locations.

What's Included

- (1) MMR-20-BE wired remote controller
- (1) Lipped gasket (preinstalled)
- (1) Flat gasket (optional)
- (2) Stainless steel threaded studs
- (4) Stainless steel nuts (7 mm)
- (4) Stainless steel washers
- (1) Aluminum C-bracket
- (1) User Manual

Safety Considerations

- While this product is designed to be water-resistant, it should never be submerged under water or subjected to high-pressure water spray.
- Do not mount in areas of extreme heat.
- Ensure this product is securely installed so that it does not come loose in the event of a collision/sudden jolt or as a result of repeated vibrations during normal operation.
- Check before drilling to make sure that you will not be drilling into a fuel tank, gas/brake line, wiring harness, or other vital system.
- Secure all wiring as needed, using cable ties or wire clamps to protect them from moving parts and sharp edges.

Mounting & Installation

A 2-inch (50 mm) hole is required for mounting, along with adequate rear access to secure/tighten the hardware. The included hardware accommodates installations in flat panels up to 1.5-inches (38 mm) thick.

The C-bracket is designed with break lines to allow adjustment for different mounting panel thicknesses. To remove a leg section, use pliers and bend back and forth at a break line to separate. Be mindful of resultant sharp edges and file if necessary.

! IMPORTANT

Make sure to carefully plan the routing of the remote's connection cables prior to cutting or drilling any panels.

1. Select an appropriate mounting location and cut a 2-inch (50 mm) hole using an appropriate tool/hole saw.
2. The preinstalled lipped gasket can be used for most installations or where an existing mounting hole may be slightly larger than 2-inches. If you desire a reduced profile appearance, you may replace the lipped gasket with the optional flat gasket.
3. Apply thread sealer (not included) onto the threaded studs and insert them into the inserts at the rear of the MMR-20-BE, and hand tighten.

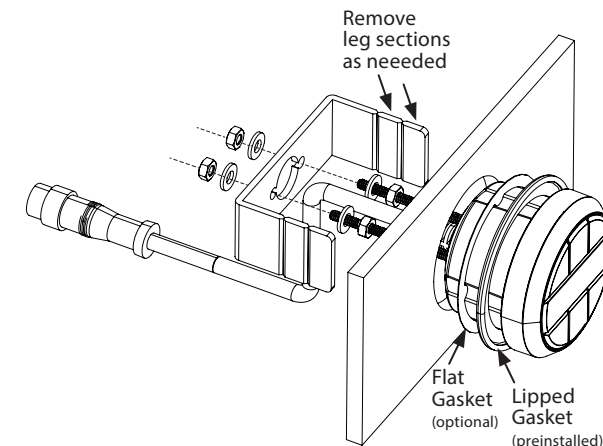

4. Install a nut and washer near the middle section of each stud (see diagram) and place the MMR-20-BE into the mounting hole.
5. From behind the mounting panel, slide the C-bracket onto the threaded studs and press it forward, towards the MMR-20-BE
6. Apply thread sealer and adjust the position of the previously installed nuts and washers to support the C-bracket while still allowing the legs to of the C-bracket to press against the rear of the mounting panel.
7. Apply thread sealer and install a remaining nut and washer onto each stud. Tighten the C-bracket to the mounting panel.

Thin Panel Installation Example

Route the cable through the C-bracket as shown to avoid chafing/damage (with the strain relief extended past the center hole).

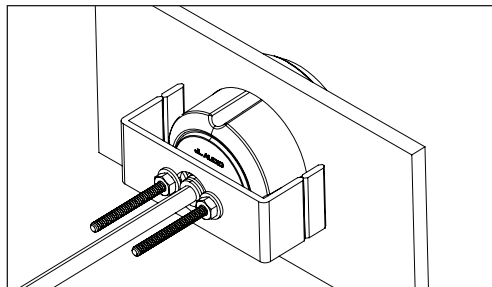

Thick Panel Installation Example

Route the cable as shown to avoid chafing/damage (not through the center hole in the C-bracket).

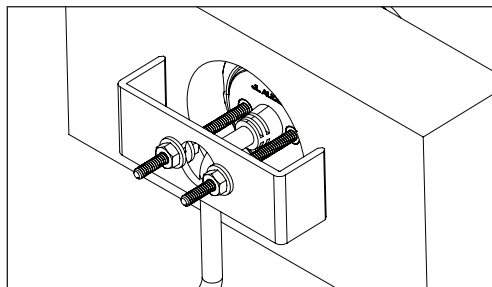

Connection Cables

Connection cables (sold separately) are available in 6 ft. (MMC-6) and 25 ft. (MMC-25) lengths to suit different mounting locations. A Y-splitter (MMC-2Y) (sold separately) may be used to connect an additional remote to a single source unit.

Each remote controller may be connected a maximum 75 ft. (22.8 m) of cable length away from its source unit. Remote controllers and cables utilize a 5-pin connector with a watertight threaded collar to securely mate their ends together. Connectors are keyed and must be aligned to fit properly. Once connected, make sure that cables are securely routed using cable ties or wire clamps, keeping connections away from areas where they could be submerged in water.







LED Source Indicators

Blue LED indicators on the front of the remote controller are used to report the currently selected source. Pressing the **SOURCE** button will cycle through each source option (RADIO/USB/Bluetooth®/AUX).

Since the MMR-20-BE does not incorporate a display screen, all available tuner options (AM/FM/WB SiriusXM®) are combined as "RADIO". When RADIO is chosen, the last tuner used will be selected. To change tuners, use the MediaMaster® source unit.

Control Functions

Below is a list of MMR-20-BE command functions. The functionality of some controls will vary depending on the current source and/or last tuner selected. Note: The MediaMaster® source unit only accepts commands from the MMR-20-BE when its display is on a **Now Playing** Screen or in the **SOURCE: Select** menu screen.

 SOURCE	<ul style="list-style-type: none">• Press to turn the source unit ON• Press to cycle through sources (RADIO/USB/Bluetooth®/AUX)• Press and hold to turn the source unit OFF
 VOL	<ul style="list-style-type: none">• Press to increase volume
 VOL	<ul style="list-style-type: none">• Press to decrease volume
 MUTE	<ul style="list-style-type: none">• Press to mute audio (AM/FM/WB SiriusXM®/AUX)• Press to pause or resume the current selection (USB/Bluetooth®)
 ▶▶	<ul style="list-style-type: none">• Press to select the next Favorite (AM/FM/WB SiriusXM®)• Press to select the next track (USB/Bluetooth®)• Press and hold to fast-forward (USB)
 ◀◀	<ul style="list-style-type: none">• Press to select the previous Favorite (AM/FM/WB SiriusXM®)• Press to select the previous track (USB/Bluetooth®)• Press and hold to fast-rewind (USB)

MMR-20-BE Backlight Settings

Brightness settings for the MMR-20-BE's LEDs and buttons can be accessed in the MediaMaster® source unit's System Settings menu. Adjustments can be set independently for Day and Night lighting modes.

To access the remote controller backlight settings on the MediaMaster® source unit:

1. Press and hold **SETTINGS** to access the **System Settings: Main Menu**.

2. Turn **VOL/SEL** to **Display** and press to enter.
3. Use **VOL/SEL** to select **Day Mode** or **Night Mode** and press to enter.
4. Turn **VOL/SEL** to **Brightness** and press to enter.
5. Turn **VOL/SEL** to **Remote Backlight** and press to enter.
6. Turn **VOL/SEL** to adjust the remote's brightness and press to set.

IP67 Water Resistance Rating

This product has been tested to withstand immersion in water, up to 1 meter (3.28 ft.) deep, for up to 30 minutes (when properly installed). Note: while designed to be water resistant, this product should never be submerged under water for prolonged periods or subjected to activity that creates pressure on it that exceeds its depth rating.

2-Year Limited Warranty (U.S.A.)

Visit www.jlaudio.com for warranty details.

For Service Information in the U.S.A. please call JL Audio customer service: (954) 443-1100 during normal business hours (Eastern Time) • JL Audio, Inc • 10369 N Commerce Parkway, Miramar, FL 33025

International Warranties:

Products purchased outside the United States of America are covered only by that country's distributor and not by JL Audio, Inc.